

# Serie Civili

## Sistema 45

### System 45

#### Wiring Accessories

**Design:**

B. Dall'Eco  
M. Hasuike  
H.M.R.  
A. Van Omck  
L. Merletti



## Indice

### Index

#### Serie civile NOIR AX

##### NOIR AX Wiring accessories

Prima serie italiana conforme alla normativa europea EN60669 AX, è stata progettata per sostenere un carico con corrente fino a 20A, anche con carichi induttivi.

*The very first Italian series complying with EN60669 AX European standard, it has been conceived to withstand a load with currents up to 20A, even with inductive loads.*

274



#### Serie civile BANQUISE

##### BANQUISE Wiring accessories

Serie realizzata nel colore "bianco ghiaccio" si adatta perfettamente a qualsiasi ambiente, in abbinamento alla prima placca illuminabile.

*"Polar white" series that perfectly fits with all rooms, combined with the first lightable front plate.*

282



#### Serie civile BLANC

##### BLANC Wiring accessories

Serie classica dall'eleganza esclusiva che, con la completezza della propria gamma, meglio si adatta ad ogni tipo di esigenza.

*A classical and elegant exclusive series with a complete range that makes it suitable for any kind of requirements.*

292



#### Serie civile RAL

##### RAL Wiring accessories

Caratterizzata dal colore neutro RAL7035, è la serie ideale per installazioni in contenitori di superficie per impiego civile o industriale.

*Characterized by a "neutral" colour RAL7035, it is suitable for installation in "surface" enclosures for domestic and industrial applications.*

298



#### Accessori comuni a tutte le serie

##### Common accessories for all series

301

#### Serie civili Placche S45

##### Front plates Wiring accessories

Raffinati design per ogni ambiente della casa.

*An elegant design for each room of your house.*

306



#### Supporti e contenitori S45

##### Frames and enclosures

Accessori di completamento.

*Complementary accessories.*

324





# Serie Noir AX

## Noir AX Series

### Interruttori 250V 1 way switches 250V

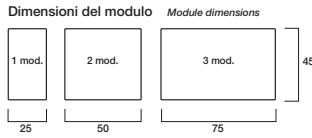

Le dimensioni, salvo diversamente specificato, sono in mm  
Dimensions, except where otherwise specified, are in mm

# Sistema 45

274



45301ST



45301



45301G



45310



45310L

#### Descrizione *Description*

**45301ST**  
Corpo interruttore 1P 16AX da completare con tasti 1 o 2 moduli  
*16AX one way 1P switch mechanism to be used with 1 or 2 modules rockers*

**45301**  
Interruttore 1P 16AX - con tasto intercambiabile e meccanismo soft  
*16AX 1 way single pole switch - with interchangeable cover and soft mechanism*

**45301G**  
Interruttore 1P 16AX con gemma illuminabile - con tasto intercambiabile e meccanismo soft  
*16AX 1 way single pole switch with neon (optional) - with interchangeable cover and soft mechanism*

**45310**  
Interruttore bipolare 2P 16AX  
*16AX 1 way double pole switch*

**45310L**  
Interruttore bipolare 2P 16AX luminoso  
*16AX 1 way double pole switch with neon*

Info € □ □

② 5,70 10 100

② 9,15 10 100

② 10,34 10 100

② 17,32 10 100

② 19,07 1 10

### Deviatori 250V 2 way switches 250V



45302ST



45302



45302G

#### Descrizione *Description*

**45302ST**  
Corpo deviatore 1P 16AX da completare con tasti 1 o 2 moduli  
*16AX 2 way 1P switch mechanism to be used with 1 or 2 modules rockers*

**45302**  
Deviatore 1P 16AX - con tasto intercambiabile e meccanismo soft  
*16AX 2 way single pole switch - with interchangeable cover and soft mechanism*

**45302G**  
Deviatore 1P 16AX con gemma illuminabile - con tasto intercambiabile e meccanismo soft  
*16AX 2 way single pole switch with neon (optional) - with interchangeable cover and soft mechanism*

Info € □ □

② 6,91 10 100

② 11,18 10 100

② 12,24 10 100

### Tasti intercambiabili per interruttori e deviatori *Interchangeable rockers for 1 way switches and 2 way switches*



453TG



453TG/2

#### Descrizione *Description*

**453TG**  
Tasto intercambiabile con gemma illuminabile - 1 modulo  
*Interchangeable rocker with lightable lens - 1 module*

**453TG/2**  
Tasto intercambiabile con gemma illuminabile - 2 moduli  
*Interchangeable rocker with lightable lens - 2 modules*

Info € □ □

3,84 10 10

4,76 5 5

### Invertitori 250V *Intermediate switches 250V*



45304

#### Descrizione *Description*

**45304**  
Invertitore 16AX  
*16AX intermediate switch*

Info € □ □

② 20,43 10 100



Per la disponibilità contattare la rete commerciale  
For availability please contact sales dept.



Disponibilità fino ad esaurimento scorte  
Available until stock out



Prodotto 2 moduli adatto anche per scatola tonda  
2 modules product suitable for round box











Prodotto per scatola rettangolare inglese  
Product for British standard rectangular box



Prodotto per Export  
For Export only

## Pulsanti 250V Push buttons 250V





		Descrizione <i>Description</i>	Info	€	□	□
		<b>45305ST</b> Corpo pulsante 1P 10A NA da completare con tasti 1 o 2 moduli <i>10A 1P NO push button mechanism to be used with 1 or 2 modules rockers</i>	②	<b>5,87</b>	10	100
<b>45305ST</b>	<b>45305</b> <b>45325</b>	<b>45305</b> Pulsante 1P 10A NA - con tasto intercambiabile e meccanismo soft <i>10A single pole push button - with interchangeable cover and soft mechanism</i>	②	<b>10,06</b>	10	100
		<b>45305G</b> Pulsante 1P 10A NA con gemma illuminabile - con tasto intercambiabile e meccanismo soft <i>10A NO single pole push button with neon (optional) with interchangeable cover and soft mechanism</i>	②	<b>11,08</b>	10	100
<b>45305G</b>	<b>45305K</b> <b>45317</b>	<b>45305K</b> Pulsante 1P 10A NA - simbolo chiave <i>10A NO single pole push button - key symbol</i>	②	<b>10,06</b>	10	100
		<b>45317</b> Pulsante a tirante NA 1P 10A - con meccanismo soft <i>10A NO single pole cord switch pull to make - with soft mechanism</i>	②	<b>20,37</b>	1	10
		<b>45325</b> Pulsante 1P 10A con contatti NC+NA - con tasto intercambiabile e meccanismo soft <i>10A single pole push button + break retractive - with interchangeable cover and soft mechanism</i>	②	<b>14,03</b>	10	10
<b>45356</b>	<b>45355</b>	<b>45355</b> Doppio pulsante 1P 16A NA <i>Twin NO 16A single pole push button</i>		<b>22,09</b>	1	10
		<b>45356</b> Doppio pulsante 1P 10A NA con frecce direzionali <i>Twin NO 16A single pole push button with arrow symbols</i>		<b>22,93</b>	1	10
<b>45388S</b>		<b>45388S</b> Pulsante con targhetta 1P 10A illuminabile anche per scatola tonda - 2 moduli <i>10A single pole push button with neon and name tag label - round box - 2 modules</i>	•	<b>24,03</b>	1	6

275



Sistema 45

## Tasti intercambiabili per pulsanti *Interchangeable rockers for push buttons*

		Descrizione <i>Description</i>	Info	€	□	□
		<b>453TGP</b> Tasto intercambiabile con gemma illuminabile - 1 modulo <i>Interchangeable rocker with lightable lens - 1 module</i>		<b>3,84</b>	10	10
<b>453TGP</b>	<b>453TGP/2</b>	<b>453TGP/2</b> Tasto intercambiabile con gemma illuminabile - 2 moduli <i>Interchangeable rocker with lightable lens - 2 modules</i>		<b>4,76</b>	5	5
		<b>453TLP</b> Tasto intercambiabile con simbolo lampada illuminabile - 1 modulo <i>Interchangeable rocker with lightable lamp symbol - 1 module</i>		<b>3,84</b>	30	30
<b>453TLP</b>	<b>453TSP</b>	<b>453TSP</b> Tasto intercambiabile con simbolo suoneria illuminabile - 1 modulo <i>Interchangeable rocker with lightable bell symbol - 1 module</i>		<b>3,84</b>	30	30



## Serie Noir AX



Noir AX Series

Commutatori 250V



Rolling blind switches 250V

Sistema 45





276

		Descrizione Description	Info	€	□	□
		<b>45351</b> Commutatore 1P 10AX con frecce e posizione OFF centrale <i>10AX rolling blind single pole switch with arrows (non retractive)</i>		<b>23,30</b>	1	10
<b>45351</b>	<b>45353</b>	<b>45352</b> Commutatore 2P 10AX con frecce e posizione OFF centrale <i>10AX rolling blind double pole switch with arrows (non retractive)</i>		<b>31,45</b>	1	10
<b>45352</b>	<b>45354</b>	<b>45353</b> Pulsante commutatore 1P 10A con frecce e posizione OFF centrale <i>10A rolling blind single pole push button with arrows (retractive)</i>		<b>23,30</b>	1	10
		<b>45354</b> Pulsante commutatore 2P 10A con frecce e posizione OFF centrale <i>10A rolling blind double pole push button with arrows (retractive)</i>		<b>31,16</b>	1	10

### Copriforo Blank insert

		Descrizione Description	Info	€	□	□
		<b>45313</b> Tappo copriforo 1 modulo <i>1 module blank insert</i>		<b>1,72</b>	10	300
<b>45313</b>	<b>45313R</b>	<b>45313R</b> Tappo copriforo mezzo modulo <i>Half module blank insert</i>	△	<b>2,81</b>	8	48

### Variatori Dimmers

		Descrizione Description	Info	€	□	□
		<b>45318</b> Regolatore di luminosità 230V 50-60 Hz per carichi resistivi da 60÷900W - non dotato di filtro EMC <i>Dimmer 230V 50-60Hz for resistive loads 60÷900W The EMC filter is not included</i>	△ 	<b>52,31</b>	2	2
<b>45318</b>	<b>45348D</b>	<b>45348D</b> Regolatore di luminosità con deviatore incorporato 230V 50-60 Hz per carichi resistivi da 100÷500W - tecnologia che garantisce la "silenziosità" <i>Dimmer 230V 50-60Hz for resistive loads 100÷500W with built-in 2 way switch Noiseless technology</i>		<b>61,20</b>	1	6
		<b>45348L</b> Regolatore di luminosità con comando a pulsante 230V 50-60 Hz per carichi resistivi e induttivi da 60÷500W - tecnologia che garantisce la "silenziosità" <i>Push button dimmer 230V 50-60Hz for resistive and inductive loads 60÷500W Noiseless technology</i>		<b>69,91</b>	1	1
<b>45348L</b>		<b>Nota: 45318 utilizzabile solo in paesi non membri dell'Unione Europea</b> <b>Note: 45318 can be used in non - EU countries only</b>				

### Rivelatori di presenza Occupancy sensors

		Descrizione Description	Info	€	□	□
		<b>45368-500</b> LUCE AMICA - rivelatore a raggi infrarossi per accensione luci - 230V max 500W- ritardo spegnimento da 4s a 5min - sensibilità regolabile - lente con portata 11m e apertura 120° - uscita con contatto in scambio 8A (5A induttivi) - lente opzionale con portata 30m e apertura 80° <i>LUCE AMICA - Infrared detector for lighting control - 230V max 500W - Adjustable off delay from 4s to 5 min approx. - adjustable light sensitivity - lens with 11m range and 120° opening - exit with switching contact 8A (5A inductive) - optional lens with 30m range and 80° opening</i>	•	<b>155,23</b>	1	1
<b>45368-500</b>						



Per la disponibilità contattare la rete commerciale  
For availability please contact sales dept.



Disponibilità fino ad esaurimento scorte  
Available until stock out



Prodotto 2 moduli adatto anche per scatola tonda  
2 modules product suitable for round box







Prodotto per scatola rettangolare inglese  
Product for British standard rectangular box



Prodotto per Export  
For Export only

## Prese di corrente standard italiano Italian standard socket outlets



		Descrizione Description	Info	€	□	□
		<b>45306TS</b> Presse P11 2x10A+T - 250V - alveoli schermati <i>P11 socket outlet 2x10A + E - 250V - shuttered</i>		<b>8,65</b>	10	100
<b>45306TS</b>	<b>45306/15TS</b>	<b>45306/15TS</b> Presse bipasso P17/11 2x10/16A+T - 250V - alveoli schermati <i>Combined P17/11 socket outlet 2x10/16A + E - 250V - shuttered</i>		<b>11,18</b>	10	100
		<b>45390TS</b> Presse schuko P30 2P+T 16A 250V - alveoli schermati - 2 moduli <i>Schuko socket outlet P30 2P+E 16A 250V - shuttered - 2 modules</i>		<b>18,24</b>	5	50
<b>45390TS</b>	<b>45390/15TS</b>	<b>45390/15TS</b> Presse schuko bipasso 2P+T 10/16A 250V - alveoli schermati - 2 moduli <i>Combined schuko + Italian standard socket outlet 2P+E 10/16A 250V shuttered - 2 mod.</i>		<b>19,70</b>	5	50

277





Sistema 45

## Prese di corrente standard esteri Various standards socket outlets

		Descrizione Description	Info	€	□	□
		<b>45392TS</b> Presse standard francese 2P+T 16A 250V - alveoli schermati - 2 moduli <i>French standard socket outlet 2P+E 16A 250V - shuttered - 2 modules</i>	•△	<b>13,94</b>	5	50
<b>45397TS</b>		<b>45397TS</b> Presse standard BS1363 2P+T 13A 250V - alveoli schermati - 2 moduli <i>British standard socket outlet BS1363 2P+E 13A 250V - shuttered - 2 modules</i>	•△	<b>16,47</b>	5	50
		<b>45392TS</b>				

## Lampada estraibile portatile Portable removable light

		Descrizione Description	Info	€	□	□
		<b>45786</b> LUCE SICURA, lampada anti black-out estraibile portatile - con batterie ricaricabili e sostituibili - lampada: LED bianco ad alta efficienza - 230V - 2 moduli <i>LUCE SICURA, removable anti-black out light with rechargeable and replaceable batteries - 230V - 2 mod.</i>		<b>135,57</b>	1	6
<b>45786</b>		<b>45786B</b> Batteria (4x1,2)V - 80mAh, di ricambio per 45786 <i>Replacement battery for 45786 (4x1,2)V - 80mAh</i>		<b>14,17</b>	1	1
		<b>45786B</b>				

◇ Prodotto per scatola quadrata  
Product for British Standard  
square box only

② Prodotto 1 modulo installabile in scatola tonda  
con altro prodotto 1 modulo  
1 module product installable in round box with  
another 1 module device

□ Imballo Minimo pcs  
Min. Packaging pcs

□ Imballo Standard pcs  
Std. Packaging pcs





# Serie Noir AX

Noir AX Series

Prese TV Satellitare - Ø 9,5 mm  
TV/SAT coaxial outlets - Ø 9,5 mm

Sistema 45

278



45396MN  
45396MN-DB6

### Descrizione Description

Info € □ □

**45396MN**  
Presca diretta con porta utente IEC maschio - permette il passaggio di corrente  
*Direct socket outlet male connector - It allows the current passage*

27,98 1 10

**45396MN-DB6**  
Presca passante attenuazione 6dB - con porta utente IEC maschio  
*Through line 6dB socket - male connector*

35,94 1 10

### Prese TV/SAT con CAP - Ø 9,5 mm - Accessori TV/SAT coaxial outlets with cap - Ø 9,5 mm - Accessories



45396F

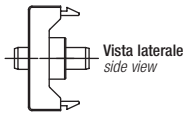

Vista laterale  
side view

**45396F**  
Presca coassiale diretta TV/SAT con porta utente femmina tipo F per frequenze fino a 2400 MHz - collegamento in ingresso e in uscita mediante connettore maschio tipo F - fornita con connettore plastico (CAP) per la connessione  
*2400 MHz female F-type connector coaxial direct TV/SAT outlet. Incoming and outgoing connection with male F-type connector. Supplied with moulded connector for coaxial cable connection*

15,52 1 10



45396IM

**45396IM**  
Presca coassiale diretta TV/SAT con porta utente IEC maschio per frequenze fino a 2400 MHz - collegamento in ingresso mediante connettore maschio tipo F - fornita con connettore plastico (CAP) per la connessione  
*2400 MHz IEC male coaxial direct TV/SAT socket. Incoming connection with male F-type connector. Supplied with moulded connector for coaxial cable connection*

19,71 1 10



CAP

**CAP**  
Connettore plastico per cavi coassiali - consente una connessione rapida ed economica - da utilizzare con prese 45396F, 45396IM, 45396IF  
*Moulded connector for coaxial cables to be used with 45396F, 45396IM and 45396IF sockets*

0,57 50 50



TVDER-DB6  
TVDER-DB10  
TVDER-DB14

**TVDER-DB6**  
Derivatore induttivo TV/SAT ad innesto su presa 45396IM, 45396IF, 45396F - attenuazione di derivazione 7dB  
*TV/SAT inductive shunt to be connected to a socket. 45396IM, 45396IF, 45396F. Attenuation 7dB*

10,09 1 6

**TVDER-DB10**  
Derivatore induttivo TV/SAT ad innesto su presa 45396IM, 45396IF, 45396F - attenuazione di derivazione 10dB  
*TV/SAT inductive shunt to be connected to a socket. 45396IM, 45396IF, 45396F. Attenuation 10dB*

9,89 1 6

**TVDER-DB14**  
Derivatore induttivo TV/SAT ad innesto su presa 45396IM, 45396IF, 45396F - attenuazione di derivazione 14dB  
*TV/SAT inductive shunt to be connected to a socket. 45396IM, 45396IF, 45396F. Attenuation 14dB*

9,89 1 6

### Prese TV passanti Through line sockets



Presca coassiale  
Coaxial socket



Derivatore induttivo  
Inductive shunt

**Nota:** TVDER-DB... permettono la trasformazione delle prese 45396IM, 45396IF, 45396F da dirette a passanti  
**Note:** TVDER-DB... they allow change the sockets 45396IM, 45396IF, 45396F from direct to through line



Per la disponibilità contattare la rete commerciale  
For availability please contact sales dept.



Disponibilità fino ad esaurimento scorte  
Available until stock out



Prodotto 2 moduli adatto anche per scatola tonda  
2 modules product suitable for round box



Prodotto per scatola rettangolare inglese  
Product for British standard rectangular box







Prodotto per Export  
For Export only

## Presa per caricatori USB universali



### Socket outlets for Universal USB chargers

	Descrizione <i>Description</i>	Info	€	□	□
 45382USB2A	<b>45382USB2A</b> Caricatore USB universale 5V 2.1A - n° 1 uscita USB frontale - alimentazione 110÷240V~ 50-60 Hz - assorbimento a riposo < 0,1 W - consente la ricarica di telefoni cellulari, riproduttori audio portatili, console portatili e ogni altro apparecchio elettronico che offra la possibilità di ricarica da una qualsiasi presa standard USB - 1 modulo <i>Universal USB charger 5V 2.1A - 1 frontal USB output - powered with 110÷240V~ 50-60 Hz - stand-by consumption &lt; 0,1 W - It allows the charging of mobile phones, mobile audio player, and all electronic devices with charging system through standard USB Inputs - 1 module</i>		30,37	1	1

## Prese telefoniche/dati Telephone and data outlets

	Descrizione <i>Description</i>	Info	€	□	□
 45324	<b>45324</b> Presa telefonica RJ11 4 pin - morsetti a vite <i>RJ11 Telephone socket outlet 4 pins - screw terminals</i>		22,83	4	24
 45328CR	<b>45328CR</b> Presa di connettore AMP RJ45 CAT5 Enhanced 8+1 pin schermata con morsetti ad incisione di isolante per connessioni tipo T568A o T568B - fumé <i>AMP RJ45 CAT5 Enhanced 8+1 pins shielded connector for T568B wiring screwless terminals - smoked</i>		39,08	1	6
 45329C5E 45329C5ES 45329C6	<b>45329C5E</b> Presa di connettore 3M RJ45 CAT5 Enhanced 8 pin con morsetti ad incisione di isolante per connessioni tipo T568A o T568B - fumé <i>3M RJ45 CAT5 Enhanced 8 pins connector for T568A or T568B wiring screwless terminals - smoked</i>		25,09	1	10
 45329C6	<b>45329C6</b> Presa di connettore 3M RJ45 CAT6 8 pin con morsetti ad incisione di isolante per connessioni tipo T568A o T568B - fumé <i>3M RJ45 CAT6 8 pins connector for T568A or T568B wiring screwless terminals - smoked</i>		37,51	1	10

## Adattatori prese dati con aggancio keystone Data outlets adaptors with keystone clipping

	Descrizione <i>Description</i>	Info	€	□	□
 45329SC	<b>45329SC</b> Adattatore per connettori RJ45 3M, AT&T, CEAM-QUBIX, KRONE, CLIPSAL, AMPHENOL, FANTON o connettori AVE RJ11, RJ45, RCA, ecc. <i>Adaptor for RJ45 3M, AT&amp;T, CEAM-QUBIX, KRONE, CLIPSAL, AMPHENOL, FANTON or AVE RJ11, RJ45, RCA, etc. connectors</i>		7,99	5	5
 45330SC		<b>45330SC</b> Adattatore per connettori RJ45 AMP, AT&T, QUBIX, CLIPSAL - fumé <i>Adaptor for AMP, SYSTIMAX (AT&amp;T), QUBIX and CLIPSAL RJ45 outlets - smoked colour</i>		7,69	5
 45332SC	<b>45332SC</b> Adattatore per connettori RJ45 Infra+ Schneider electric - fumé <i>Adaptor for Infra+ Schneider electric RJ45 outlets - smoked colour</i>		8,07	5	5

279



Sistema 45





## Serie Noir AX

Noir AX Series

Segnalazioni acustiche  
Acoustic signals

Sistema 45

280



45328  
45329



45381

### Descrizione Description

Info

€

□

□

45328  
Suoneria squillante 12Vca 8VA  
*Ringling bell 12Vac 8VA*

34,75 1 10

45329  
Suoneria squillante 230Vca  
*Ringling bell 230Vac*

39,41 1 10

45330  
Ronzatore 12Vca 8VA  
*Buzzer 12Vac 8VA*

27,30 1 10

45331  
Ronzatore 230Vca  
*Buzzer 230Vac*

34,71 1 10

45381  
Segnalatore ausiliario d'allarme con possibilità di memorizzazione allarme per 5 secondi - 12-24Vca/cc - regolazione frontale intensità sonora - pressione acustica 86dB a 1 m - LED frontale di segnalazione  
*Auxiliary alarm with possibility to time the bell for 5 seconds - 12/24Vcc/ac power supply - acoustic level 86 dB at 1m - frontal signalling LED*

55,89 1 10

**Nota: Utilizzare solo per servizio ad intermittenza. Tempo massimo di utilizzo continuo 5" con relativa pausa di 15"**

*Note: Use only for intermittent service. Maximum time of continuous use 5" with relative pause of 15"*

## Comfort Comfort



45346

### Descrizione Description

Info

€

□

□

45346  
Regolatore di luminosità per ballast Philips o similari - contatto 4A/250Vca - regolazione 1÷10Vcc  
*Dimmer for Philips ballast - 4A/250Vca contact 1÷10 Vdc adjustment*

103,62 1 6

## Gestione della temperatura Temperature control



45385SW

### Descrizione Description

Info

€

□

□

45385SW  
Termostato elettronico 230V - range da 5°C a 30°C - commutazione estate/inverno - uscita con contatti in scambio NC+NA 5A (2A induttivi) - 3 moduli  
*Electronic Thermostat 230V - range 5°C 30°C - winter/summer selection - changeover relay output NC+NO 5A (2A inductive) - 3 modules*

110,41 1 1



Per la disponibilità contattare la rete commerciale  
For availability please contact sales dept.



Disponibilità fino ad esaurimento scorte  
Available until stock out



Prodotto 2 moduli adatto anche per scatola tonda  
2 modules product suitable for round box





Prodotto per scatola rettangolare inglese  
Product for British standard rectangular box



Prodotto per Export  
For Export only

## Sistema di chiamata Call system

	Descrizione Description	Info	€	□	□	281
 <b>45387C</b>	<b>45387C</b> Relè statico bistabile (tipo Flip-Flop SR) 12Vca/cc per impianti di chiamata - 2 uscite: per segnalazione ottica (lampeggiante o fissa) e per segnalazione acustica (suono continuo o temporizzato da 3 secondi a 1 minuto) - attivazione e tacitazione da più punti con normali pulsanti NA collegati in parallelo - 1 modulo <i>Static bistable relay (type Flip-Flop SR) 12Vac/dc for call systems - 2 outputs: for visual signals (flashing or fixed) and acoustic signals (continuous sound or at intervals of 3 seconds to 1 minute) - activated and silenced from various points using normal NO buttons connected in parallel - 1 module Intercom system relay 12Vac/dc</i>		133,24	1	1	
 <b>KITCHIAMATA1</b>	<b>KITCHIAMATA1</b> Kit base per sistema di chiamata d'emergenza La confezione contiene: - n° 1 45387C relè per impianti di chiamata 12Vca/cc; - n° 1 45381 segnalatore ausiliario d'allarme 85dB 10÷28Vca/cc; - n° 1 45382G trasformatore 230/12V~ 2VA; - n° 1 45376 portalampada sporgente; - n° 1 0212 lampada di segnalazione con fili 6/12V~; - n° 1 45350 pulsante 1P 16A NA con scritta "RESET" sulla piastrina neutra; - n° 1 45317 pulsante 1P 10A NA a tirante; - n° 3 45B63 supporti con viti per scatole rettangolari 3 moduli <i>Basic kit base for emergency call system</i> <i>The packet contains: - n. 1 45387C call system relay 12Vac/dc;</i> <i>- n. 1 45381 auxiliary alarm bell 85dB 10÷28Vac/dc;</i> <i>- n. 1 45382G transformer 230/12V~ 2VA;</i> <i>- n. 1 45376 prominent lamp holder;</i> <i>- n. 1 0212 signalling lamp with wires 6/12V~;</i> <i>- n. 1 45350 switch push to make retractive with "RESET" written on the blank cover;</i> <i>- n. 1 45317 cord switch pull to make retractive 1P 10A NO;</i> <i>- n. 3 45B63 frames with screws for 3 modules rectangular boxes</i>		272,49	1	1	



### Schema di Collegamento 45387C Connection Diagram 45387C

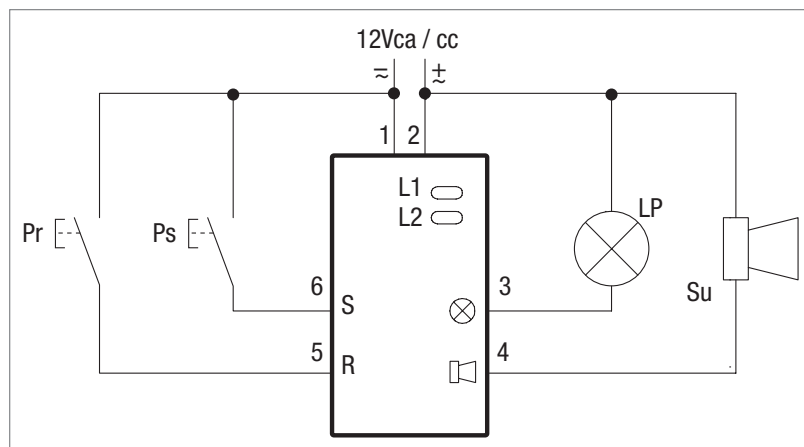

- Nota:** ✓ per il corretto funzionamento del relè è necessario prevedere un trasformatore 12 Vca oppure un alimentatore 12 Vcc opportunamente dimensionati  
 ✓ se il relè è alimentato in corrente alternata la tensione efficace sui carichi (lampada e suoneria) è pari alla metà della tensione di alimentazione
- Note:** ✓ for the proper functioning of the relay it is necessary to provide a transformer 12 Vac or a power supply 12 Vdc appropriately sized  
 ✓ If the relay is powered in alternating current, the RMS voltage on the loads (lamp and sounder) is equal to the half of powering voltage.

## Trasformatori Transformers

	Descrizione Description	Info	€	□	□
 <b>45382G</b>	<b>45382G</b> Trasformatore 230/12V 2VA <i>Transformer 230/12V 2VA</i>		56,41	1	6

◇ Prodotto per scatola quadrata  
Product for British Standard square box only

② Prodotto 1 modulo installabile in scatola tonda con altro prodotto 1 modulo  
1 module product installable in round box with another 1 module device

□ Imballo Minimo pcs  
Min. Packaging pcs

□ Imballo Standard pcs  
Std. Packaging pcs



# Serie Banquise (RAL 9016)

## Banquise Series (RAL 9016)

### Interruttori 250V

#### 1 way switches 250V

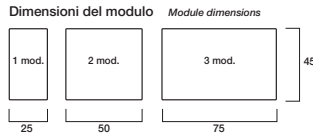

Le dimensioni, salvo diversamente specificato, sono in mm  
Dimensions, except where otherwise specified, are in mm

# Sistema 45

282



45301ST 45B01 45B01G



45B01R 45B10 45B10L  
45B10-20



45B73

Descrizione <i>Description</i>	Info	€	□	□
<b>45301ST</b> Corpo interruttore 1P 16AX da completare con tasti 1 o 2 moduli <i>16AX one way 1P switch mechanism to be used with 1 or 2 modules rockers</i>	②	5,70	10	100
<b>45B01</b> Interruttore 1P 16AX - con tasto intercambiabile e meccanismo soft <i>16AX 1 way single pole switch - with interchangeable cover and soft mechanism</i>	②	3,52	10	100
<b>45B01G</b> Interruttore 1P 16AX con gemma illuminabile - con tasto intercambiabile e mecc. soft <i>16AX 1 way single pole switch with neon (optional) - with interchangeable cover and soft mech.</i>	②	7,20	10	100
<b>45B01R</b> Interruttore 1P 16A - mezzo modulo <i>16A 1 way single pole switch - half module</i>	△	7,13	4	24
<b>45B10</b> Interruttore bipolare 2P 16AX <i>16AX 1 way double pole switch</i>	②	12,65	10	100
<b>45B10-20</b> Interruttore bipolare 2P 20AX <i>20AX 1 way double pole switch</i>	②	12,93	10	100
<b>45B10L</b> Interruttore bipolare 2P 16AX luminoso <i>16AX 1 way double pole switch with neon</i>	②	15,53	1	10
		<i>a commessa upon request</i>		
<b>45B73</b> Interruttore bipolare 2P 16A con chiave - la chiave esce in entrambe le posizioni <i>16A 1 way double pole key switch - the key exists in both positions</i>		46,54	1	10

**Note:** ✓ a richiesta gli interruttori a chiave 45B73 possono essere forniti con chiave estraibile solo in posizione di aperto

✓ gli articoli illuminabili sono forniti senza lampada di segnalazione

**Note:** ✓ 45B73 key switches can be supplied with key removable only in the open position upon request

✓ lightable articles are supplied without lamp

### Deviatori 250V 2 way switches 250V



45302ST 45B02 45B02G



45B02R

Descrizione <i>Description</i>	Info	€	□	□
<b>45302ST</b> Corpo deviatore 1P 16AX da completare con tasti 1 o 2 moduli <i>16AX two way 1P switch mechanism to be used with 1 or 2 modules rockers</i>	②	6,91	10	100
<b>45B02</b> Deviatore 1P 16AX - con tasto intercambiabile e meccanismo soft <i>16AX 2 way single pole switch - with interchangeable cover and soft mechanism</i>	②	4,73	10	100
<b>45B02G</b> Deviatore 1P 16AX con gemma illuminabile - con tasto intercambiabile e meccanismo soft <i>16AX 2 way single pole switch with neon (optional) - with interchangeable cover and soft mechanism</i>	②	8,21	10	100
<b>45B02R</b> Deviatore 1P 16A - mezzo modulo <i>16A 2 way single pole switch - half module</i>	△	8,02	4	24

### Invertitori 250V Intermediate switches 250V



45B04

Descrizione <i>Description</i>	Info	€	□	□
<b>45B04</b> Invertitore 16AX <i>16AX intermediate switch</i>	②	15,45	10	100



Per la disponibilità contattare la rete commerciale  
For availability please contact sales dept.



Disponibilità fino ad esaurimento scorte  
Available until stock out



Prodotto 2 moduli adatto anche per scatola tonda  
2 modules product suitable for round box



Prodotto per scatola rettangolare inglese  
Product for British standard rectangular box



Prodotto per Export  
For Export only

## Tasti intercambiabili per interruttori e deviatori

### Interchangeable rockers for 1 way switches and 2 way switches

	Descrizione <i>Description</i>	Info	€	□	□
	<b>45BT/2</b> Tasto intercambiabile neutro - 2 moduli <i>Neutral interchangeable rocker - 2 modules</i>		<b>2,66</b>	5	5











45BT/2

283



Sistema 45

## Pulsanti 250V Push buttons 250V

	Descrizione <i>Description</i>	Info	€	□	□
	<b>45305ST</b> Corpo pulsante 1P 10A NA da completare con tasti 1 o 2 moduli <i>10A 1P NO push button mechanism to be used with 1 or 2 modules rockers</i>	②	<b>5,87</b>	10	100
	<b>45B05</b> Pulsante 1P 10A NA - con tasto intercambiabile e meccanismo soft <i>10A single pole push button - with interchangeable cover and soft mechanism</i>	②	<b>4,87</b>	10	100
	<b>45B05G</b> Pulsante 1P 10A NA con gemma illuminabile - con tasto intercambiabile e meccanismo soft <i>10A NO single pole push button with neon (optional) - with interchangeable cover and soft mechanism</i>	②	<b>7,69</b>	10	100
	<b>45B17</b> Pulsante a tirante NA 1P 10A - con meccanismo soft <i>10A NO single pole cord switch pull to make - with soft mechanism</i>	②	<b>14,93</b>	1	10
	<b>45B25</b> Pulsante 1P 10A con contatti NC+NA - con tasto intercambiabile e meccanismo soft <i>10A single pole push button + break retractive - with interchangeable cover and soft mechanism</i>	②	<b>8,58</b>	10	10
	<b>45B50</b> Pulsante 1P 16A NA con piastrina neutra <i>16A NO single pole push button with blank cover</i>		<b>15,22</b>	1	10
	<b>45B55</b> Doppio pulsante 1P 16A NA <i>Twin NO 16A single pole push button</i>		<b>14,75</b>	1	10
	<b>45B56</b> Doppio pulsante 1P 10A NA con frecce direzionali <i>Twin NO 16A single pole push button with arrow symbols</i>		<b>14,82</b>	1	10
	<b>45B88</b> Pulsante con targhetta portanome 1P 16A illuminabile (lampada a siluro 6x28mm 24V 3W max) - 2 moduli <i>16A single pole push button with neon (optional, use 6x28mm 24V 3W torpedo lamps max) and name tag label - 2 modules</i>		<b>19,79</b>	1	6
	<b>45B88S</b> Pulsante con targhetta 1P 10A illuminabile anche per scatola tonda - 2 moduli <i>10A single pole push button with neon and name tag label - round box - 2 modules</i>	•	<b>18,98</b>	1	6

45305ST

45B05  
45B25

45B05G

45B17

45B50

45B55

45B56

45B88

45B88S



## Serie Banquise (RAL 9016)

Banquise Series (RAL 9016)

Tasti intercambiabili per pulsanti  
Interchangeable rockers for push buttons





Sistema 45

284

	Descrizione Description	Info	€	□	□
	<b>45BTGP</b> Tasto intercambiabile con gemma illuminabile - 1 modulo Interchangeable rocker with lightable lens - 1 module		3,30	10	10

45BTGP

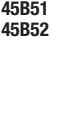

### Commutatori 250V Rolling blind switches 250V

	Descrizione Description	Info	€	□	□
	<b>45B51</b> Commutatore 1P 10AX con frecce e posizione OFF centrale 10AX rolling blind single pole switch with arrows (non retractive)		18,40	1	10
	<b>45B52</b> Commutatore 2P 10AX con frecce e posizione OFF centrale 10AX rolling blind double pole switch with arrows (non retractive)		20,26	1	10
	<b>45B53</b> Pulsante commutatore 1P 10A con frecce e posizione OFF centrale 10A rolling blind single pole push button with arrows (retractive)		18,16	1	10
	<b>45B54</b> Pulsante commutatore 2P 10A con frecce e posizione OFF centrale 10A rolling blind double pole push button with arrows (retractive)		19,48	1	10

45B51  
45B52

45B53  
45B54

### Copriforo Blank insert

	Descrizione Description	Info	€	□	□
	<b>45B08</b> Uscita Cord outlet		2,91	10	300
	<b>45B13</b> Tappo copriforo 1 modulo Blank insert 1 module		1,09	10	300
	<b>45B13R</b> Tappo copriforo mezzo modulo Blank insert half module	△	2,75	8	48

45B08

45B13

45B13R

### Rivelatori di presenza Occupancy sensors

	Descrizione Description	Info	€	□	□
	<b>45B68-500</b> LUCE AMICA - rivelatore a raggi infrarossi per accensione luci - 230V max 500W - ritardo spegnimento da 4s a 5min - sensibilità regolabile - lente con portata 11m e apertura 120° - uscita con contatto in scambio 8A (5A induttivi) - lente opzionale con portata 30m e apertura 80° LUCE AMICA - Infrared detector for lighting control - 230V max 500W Adjustable off delay from 4s to 5 min approx. - adjustable light sensitivity - lens with 11m range and 120° opening - exit with switching contacts 8A (5A inductive) - optional lens with 30m range and 80° opening	•	143,13	1	1

45B68-500



Per la disponibilità contattare la rete commerciale  
For availability please contact sales dept.



Disponibilità fino ad esaurimento scorte  
Available until stock out



Prodotto 2 moduli adatto anche per scatola tonda  
2 modules product suitable for round box







Prodotto per scatola rettangolare inglese  
Product for British standard rectangular box



Prodotto per Export  
For Export only

## Prese di corrente standard italiano Italian standard socket outlets





		Descrizione <i>Description</i>	Info	€	□	□
		<b>45B06TS</b> Presse P11 2x10A+T - 250V - alveoli schermati <i>P11 socket outlet 2x10A + E - 250V - shuttered</i>	②	<b>5,81</b>	10	100
<b>45B06TS</b>	<b>45B06/15TS</b>	<b>45B06/15TS</b> Presse bipasso P17/11 2x10/16A+T - 250V - alveoli schermati <i>Combined socket outlet P17/11 2x10/16A + E - 250V - shuttered</i>	②	<b>6,27</b>	10	100
		<b>45B90TS</b> Presse schuko P30 2P+T 16A 250V - alveoli schermati - 2 moduli <i>Schuko socket outlet P30 2P+E 16A 250V - shuttered - 2 modules</i>	•	<b>10,67</b>	5	50
<b>45B90TS</b>		<b>45B90/15TS</b> Presse schuko bipasso P40 2P+T 10/16A 250V - alveoli schermati - 2 moduli <i>Combined schuko + Italian standard socket outlet 2P+E 10/16A 250V shuttered 2 modules</i>	•	<b>12,02</b>	5	50
		<b>45B90/15TS</b>				

285



Sistema 45

## Prese di corrente standard esteri *Various standards socket outlets*

		Descrizione <i>Description</i>	Info	€	□	□
		<b>45B33</b> Presse Euroamericana 2P 16A 250V <i>Euroamerican socket outlet 2P 16A 250V</i>	② Δ 	<b>6,52</b>	10	100
<b>45B33</b>		<b>45B92TS</b> Presse standard francese 2P+T 16A 250V - alveoli schermati - 2 moduli <i>French standard socket outlet 2P+E 16A 250V - shuttered - 2 modules</i>	• Δ	<b>10,54</b>	5	50
		<b>45B97TS</b> Presse standard BS1363 2P+T 13A 250V - alveoli schermati - 2 moduli <i>British standard socket outlet BS1363 2P+E 13A 250V - shuttered - 2 modules</i>	• Δ	<b>15,13</b>	5	50
<b>45B92TS</b>		<b>Note:</b> 45B33, 45B33S, utilizzabili solo in paesi non membri dell'Unione Europea <b>Note:</b> 45B33, 45B33S, can be used in non - EU countries only				
		<b>45B97TS</b>				





# Serie Banquise (RAL 9016)

Banquise Series (RAL 9016)

Prese TV Satellitare - Ø 9,5 mm  
TV/SAT coaxial outlets - Ø 9,5 mm

# Sistema 45

286



45B96MN  
45B96MN-DB6

### Descrizione Description

Info € □ □

<b>45B96MN</b> Presca diretta con porta utente IEC maschio - permette il passaggio di corrente <i>Direct socket outlet male connector - It allows the current passage</i>	<b>17,46</b>	1	10
<b>45B96MN-DB6</b> Presca passante attenuazione 6dB - con porta utente IEC maschio <i>Through line 6dB socket - male connector</i>	<b>25,36</b>	1	10

### Prese TV/SAT con CAP - Ø 9,5 mm - Accessori TV/SAT coaxial outlets with cap - Ø 9,5 mm - Accessories



45B96F

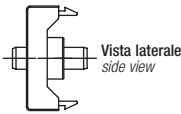

Vista laterale  
side view



45B96IM



CAP



TVDER-DB6  
TVDER-DB10  
TVDER-DB14

### Descrizione Description

Info € □ □

<b>45B96F</b> Presca coassiale con porta utente femmina tipo F per frequenze fino a 2400 MHz - collegamento in ingresso e in uscita mediante connettore maschio tipo F - fornita con connettore plastico (CAP) per la connessione <i>2400 MHz female F-type coaxial socket. Incoming and outgoing connection with male F-type connector - Supplied with moulded connector for coaxial cable connection</i>	<b>11,46</b>	1	10
<b>45B96IM</b> Presca coassiale con porta utente IEC maschio per frequenze fino a 2400 MHz - collegamento in ingresso mediante connettore maschio tipo F - fornita con connettore plastico (CAP) per la connessione <i>2400 MHz IEC male coaxial socket. Incoming connection with male F-type connector Supplied with moulded connector for coaxial cable connection</i>	<b>11,17</b>	1	10
<b>CAP</b> Connettore plastico per cavi coassiali - consente una connessione rapida ed economica - da utilizzare con prese 45B96F, 45B96IM <i>Moulded connector for coaxial cables to be used with 45B96F, 45B96IM and sockets</i>	<b>0,57</b>	50	50
<b>TVDER-DB6</b> Derivatore induttivo TV/SAT ad innesto su presa 45B96IM, 45B96F. Attenuazione di derivazione 7dB <i>TV/SAT inductive shunt to be connected to a socket. -45B96IM, 45B96F. Attenuation 7dB</i>	<b>10,09</b>	1	6
<b>TVDER-DB10</b> Derivatore induttivo TV/SAT ad innesto su presa 45B96IM, 45B96F. Attenuazione di derivazione 10dB <i>TV/SAT inductive shunt to be connected to a socket. -45B96IM, 45B96F. Attenuation 10dB</i>	<b>9,89</b>	1	6
<b>TVDER-DB14</b> Derivatore induttivo TV/SAT ad innesto su presa 45B96IM, 45B96F. Attenuazione di derivazione 14dB <i>TV/SAT inductive shunt to be connected to a socket. 45B96IM, 45B96F. Attenuation 14dB</i>	<b>9,89</b>	1	6

### Prese TV passanti Through line sockets

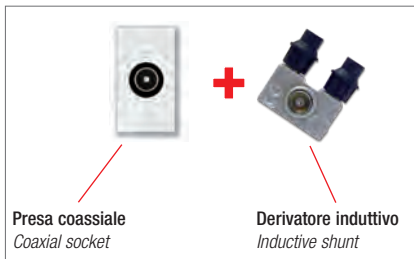

Presca coassiale  
Coaxial socket

Derivatore induttivo  
Inductive shunt

**Nota:** TVDER-DB... permettono la trasformazione delle prese 45B96IM, 45B96F da dirette a passanti  
**Note:** TVDER-DB... they allow to change the sockets 45B96IM, 45B96F from direct to through line



Per la disponibilità contattare la rete commerciale  
For availability please contact sales dept.



Disponibilità fino ad esaurimento scorte  
Available until stock out



Prodotto 2 moduli adatto anche per scatola tonda  
2 modules product suitable for round box



Prodotto per scatola rettangolare inglese  
Product for British standard rectangular box



Prodotto per Export  
For Export only

## Presa per caricatori USB universali

### Socket outlets for Universal USB chargers



	Descrizione <i>Description</i>	Info	€	□	□
 45B82USB2A	<b>45B82USB2A</b> Caricatore USB universale 5V 2.1A - n° 1 uscita USB frontale - alimentazione 110÷240V~ 50-60 Hz - assorbimento a riposo < 0,1 W - consente la ricarica di telefoni cellulari, riproduttori audio portatili, consoles portatili e ogni altro apparecchio elettronico che offra la possibilità di ricarica da una qualsiasi presa standard USB 1 modulo <i>Universal USB charger 5V 2.1A - 1 frontal USB output - powered with 110÷240V~ 50-60 Hz - stand-by consumption &lt; 0,1 W - It allows the charging of mobile phones, mobile audio player, and all electronic devices with charging system through standard USB Inputs - 1 module</i>	29,23	1	1	

287



Sistema 45

## Prese telefoniche/dati *Telephone and data outlets*

	Descrizione <i>Description</i>	Info	€	□	□
 45B24	<b>45B24</b> Presa telefonica RJ11 4 pin - morsetti a vite <i>RJ11 Telephone socket outlet 4 pins - screw terminals</i>	17,56	4	24	
 45B29C5E 45B29C6	<b>45B29C5E</b> Presa di connettore 3M RJ45 CAT5 Enhanced 8 pin con morsetti ad incisione di isolante per connessioni tipo T568A o T568B <i>3M RJ45 CAT5 Enhanced 8 pins connector for T568A or T568B wiring screwless terminals</i>	18,91	1	10	
	<b>45B29C6</b> Presa di connettore 3M RJ45 CAT6 8 pin con morsetti ad incisione di isolante per connessioni tipo T568A o T568B <i>3M RJ45 CAT6 8 pins connector for T568A or T568B wiring screwless terminals</i>	29,82	1	10	



# Serie Banquise (RAL 9016)



Banquise Series (RAL 9016)

# Sistema 45

## Adattatori prese dati con aggancio keystone

Data outlets adaptors with keystone clipping



288

		Descrizione Description	Info	€	□	□
		<b>45B29SC</b> Adattatore per connettori RJ45 3M, AT&T, CEAM-QUBIX, KRONE, CLIPSAL, AMPHENOL, FANTON o connettori AVE RJ11, RJ45, RCA, ecc. <i>Adaptor for RJ45 3M, AT&amp;T, CEAM-QUBIX, KRONE, CLIPSAL, AMPHENOL, FANTON or AVE RJ11, RJ45, RCA, etc. connectors</i>		<b>6,84</b>	5	5
<b>45B29SC</b>	<b>45B30SC</b>	<b>45B30SC</b> Adattatore per connettori RJ45 AMP, AT&T, QUBIX, CLIPSAL <i>Adaptors for AMP, SYSTIMAX (AT&amp;T), QUBIX and CLIPSAL RJ45 outlets</i>		<b>6,79</b>	5	5
		<b>45332SC</b> Adattatore per connettori RJ45 Infra+ Schneider electric - fumé <i>Adaptor for Infra+ Schneider electric RJ45 outlets - smoked colour</i>		<b>8,07</b>	5	5
<b>45332SC</b>						

## Interruttori automatici magnetotermici MCBs

		Descrizione Description	Info	€	□	□
		<b>45B52NX10</b> Interruttore automatico magnetotermico 1P+N 10A p.i. 3000A - 1 modulo - si monta solo su supporti 45360 o 45364 <i>1P+N 10A Miniature Circuit Breaker - Breaking capacity 3000A - 1 module To be used with 45360 and 45364 frames</i>		<b>67,72</b>	1	10
<b>45B52NX10</b>	<b>45B52NX16</b>	<b>45B52NX16</b> Interruttore automatico magnetotermico 1P+N 16A p.i. 3000A - 1 modulo - si monta solo su supporti 45360 o 45364 <i>1P+N 16A Miniature Circuit Breaker - Breaking capacity 3000A - 1 module To be used with 45360 and 45364 frames</i>		<b>69,70</b>	1	10

## Interruttori automatici magnetotermici differenziali SRCBO

		Descrizione Description	Info	€	□	□
		<b>45B62NX16</b> Interruttore automatico magnetotermico differenziale 1P+N 16A IΔn=10mA p.i. 3000A - 2 moduli - si monta solo su supporti 45360 o 45364 <i>1P+N 16A SRCBO -IΔn 10mA - Breaking capacity 3000A - 2 modules - to be used with 45360 and 45364 frames</i>		<b>166,19</b>	1	6
<b>45B62NX16</b>		<b>45BMT</b> Adattatore per installazione orizzontale di interruttori automatici magnetotermici su supporti standard Sistema 45 o su contenitori/scatole da parete IP40/IP55 - 2 moduli <i>Adaptor for horizontal installation of MCBs on standard System 45 frames or in wall mounted enclosures/boxes IP40/IP55 - 2 modules</i>		<b>3,58</b>	1	6
						

45BMT

### Esplso Installativo Installation diagram

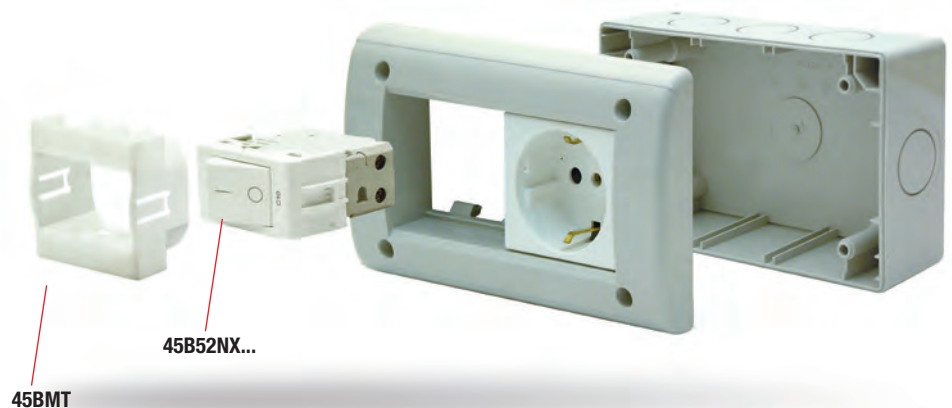

Per la disponibilità contattare la rete commerciale  
For availability please contact sales dept.



Disponibilità fino ad esaurimento scorte  
Available until stock out



Prodotto 2 moduli adatto anche per scatola tonda  
2 modules product suitable for round box



Prodotto per scatola rettangolare inglese  
Product for British standard rectangular box



Prodotto per Export  
For Export only

## Protezioni Protections

	Descrizione <i>Description</i>	Info	€	<input type="checkbox"/>	<input type="checkbox"/>
	<b>45B07</b> Portafusibile per fusibili in miniatura 1P 10A 250V - per fusibili Ø 5x20 mm - fornito senza fusibile <i>10A single pole 250V fuse holder for Ø 5x20mm miniature fuses - fuse not included</i>	②	<b>12,96</b>	1	10



45B07

## Lampade segnapasso/segnagradino *Step marker lights*

	Descrizione <i>Description</i>	Info	€	<input type="checkbox"/>	<input type="checkbox"/>
	<b>45B70-1LDW</b> Lampada segnapasso 12-24-230 Vac - LED bianco - 2 moduli <i>Step marker light 12-24-230Vac - 2 modules</i> <i>Lamp to be purchased separately (0220SL)</i>	•	<b>26,85</b>	1	1

45B70-1LDW



## Lampada estraibile portatile *Portable removable light*

	Descrizione <i>Description</i>	Info	€	<input type="checkbox"/>	<input type="checkbox"/>
	<b>45786BB</b> LUCE SICURA, lampada anti black-out estraibile portatile con batterie ricaricabili e sostituibili - lampada: LED bianco ad alta efficienza - 230V - 2 moduli <i>LUCE SICURA, removable anti-black out light with rechargeable and replaceable batteries - 230V - 2 modules</i>	•	<b>111,01</b>	1	6
	<b>45786B</b> Batteria (4x1,2)V - 80mAh, di ricambio per 45786BB <i>Replacement battery for 45786BB (4x1,2)V - 80mAh</i>		<b>126,57</b>	1	1

45786BB

45786B

## Segnalazioni acustiche *Acoustic signals*

	Descrizione <i>Description</i>	Info	€	<input type="checkbox"/>	<input type="checkbox"/>
	<b>45B28</b> Suoneria squillante 12Vca 8VA <i>Ringling bell 12Vac 8VA</i>		<b>24,48</b>	1	10
	<b>45B29</b> Suoneria squillante 230Vca <i>Ringling bell 230Vac</i>		<b>30,26</b>	1	10
<b>45B28</b> <b>45B29</b>	<b>45B30</b> Ronzatore 12Vca 8VA <i>Buzzer 12Vac 8VA</i>		<b>18,50</b>	1	10
	<b>45B31</b> Ronzatore 230Vca <i>Buzzer 230Vac</i>		<b>24,38</b>	1	10
	<b>45B81</b> Segnalatore ausiliario d'allarme con possibilità di memorizzazione allarme per 5 secondi - 12-24Vca/cc - regolazione frontale intensità sonora - pressione acustica 86dB a 1 m - LED frontale di segnalazione <i>Auxiliary alarm with possibility to time the bell for 5 second - 12/24Vcc/ac power supply - acoustic level 86 dB at 1m - frontal signalling LED</i>		<b>56,44</b>	1	10

45B81

**Nota:** Utilizzare solo per servizio ad intermittenza. Tempo massimo di utilizzo continuo 5" con relativa pausa di 15"



*Note: Use only for intermittent service. Maximum time of continuous use 5 " with relative pause of 15"*







**Variatori  
Dimmers**

290

	Descrizione Description	Info	€	□	□
 45B18	<b>45B18</b> Regolatore di luminosità 230V 50-60 Hz per carichi resistivi da 60÷900W - non dotato di filtro EMC <i>Dimmer 230V 50-60Hz for resistive loads 60÷900W. The EMC filter is not included</i>	△	47,79	2	2
 45B48D	<b>45B48D</b> Regolatore di luminosità con deviatore incorporato 230V 50-60 Hz per carichi resistivi da 100÷500W - tecnologia che garantisce la "silenziosità" <i>Dimmer 230V 50-60Hz for resistive loads 100÷500W with built-in 2 way switch. Noiseless technology</i>		47,25	1	6
 45B48L	<b>45B48L</b> Regolatore di luminosità con comando a pulsante 230V 50-60 Hz per carichi resistivi e induttivi da 60÷500W - tecnologia che garantisce la "silenziosità" <i>Push button dimmer 230V 50-60Hz for resistive and inductive loads 60÷500W. Noiseless technology</i>		67,08	1	1
	<b>Nota:</b> 45B18 utilizzabile solo in paesi non membri dell'Unione Europea <b>Note:</b> 45B18 can be used in non - EU countries only				

**Sistema di chiamata Intercom system**

	Descrizione Description	Info	€	□	□
 45B87C	<b>45B87C</b> Relè statico bistabile (tipo Flip-Flop SR) 12Vca/cc per impianti di chiamata - 2 uscite: per segnalazione ottica (lampeggiante o fissa) e per segnalazione acustica (suono continuo o temporizzato da 3 secondi a 1 minuto) - attivazione e tacitazione da più punti con normali pulsanti NA collegati in parallelo - 1 modulo <i>Static bistable relay (type Flip-Flop SR) 12Vac/dc for call systems - 2 outputs: for visual signals (flashing or fixed) and acoustic signals (continuous sound or at intervals of 3 seconds to 1 minute) - activated and silenced from various points using normal NO buttons connected in parallel - 1 module call system relay 12Vac/dc</i>		130,35	1	1
 KITCHIAMATA2	<b>KITCHIAMATA2</b> Kit base per sistema di chiamata d'emergenza La confezione contiene: - n° 1 45B87C relè per impianti di chiamata 12Vca/cc; - n° 1 45B81 segnalatore ausiliario d'allarme 85dB 10÷28Vca/cc; - n° 1 45B82G trasformatore 230/12V~ 2VA; - n° 1 45376 portalampada sporgente; - n° 1 0212 lampada di segnalazione con fili 6/12V~; - n° 1 45B50 pulsante 1P 16A NA con scritta "RESET" sulla piastrina neutra; - n° 1 45B17 pulsante 1P 10A NA a tirante; - n° 3 45B63 supporti con viti per scatole rettangolari 3 moduli <i>Basic kit base for emergency call system The packet contains: - n. 1 45987C call system relay 12Vac/dc; - n. 1 45B81 auxiliary alarm bell 85dB 10÷28Vac/dc; - n. 1 45B82G transformer 230/12V~ 2VA; - n. 1 45376 prominent lamp holder; - n. 1 0212 signalling lamp with wires 6/12V~; - n. 1 45B50 switch push to make retractive with "RESET" written on the blank cover; - n. 1 45B17 cord switch pull to make retractive 1P 10A NO; 0- n. 3 45B63 frames with screws for 3 modules rectangular boxes</i>		265,31	1	1
	<b>Nota:</b> ✓ per il corretto funzionamento del relè è necessario prevedere un trasformatore 12 Vca oppure un alimentatore 12 Vcc opportunamente dimensionati ✓ se il relè è alimentato in corrente alternata la tensione efficace sui carichi (lampada e suoneria) è pari alla metà della tensione di alimentazione <b>Note:</b> ✓ for the proper functioning of the relay it is necessary to provide a transformer 12 Vac or a power supply 12 Vdc appropriately sized ✓ If the relay is powered in alternating current, the RMS voltage on the loads (lamp and sounder) is eguale to the half of powering voltage.				



Per la disponibilità contattare  
la rete commerciale  
For availability please contact  
sales dept.



Disponibilità fino ad  
esaurimento scorte  
Available until stock out



Prodotto 2 moduli adatto  
anche per scatola tonda  
2 modules product suitable  
for round box



Prodotto per scatola  
rettangolare inglese  
Product for British standard  
rectangular box



Prodotto  
per Export  
For Export  
only

## Trasformatori Transformers

	Descrizione <i>Description</i>	Info	€	□	□
	<b>45B82G</b> Trasformatore 220/12Vca 2VA <i>Transformer 220/12Vac 2VA</i>		55,41	1	6

45B82G

291





Sistema 45

## Gestione della temperatura *Temperature control*

	Descrizione <i>Description</i>	Info	€	□	□
	<b>45B85SW</b> Termostato elettronico 230V - range da 5°C a 30°C - commutazione estate/inverno - uscita con contatti in scambio NC+NA 5A (2A induttivi) - 3 moduli <i>Electronic Thermostat 230V - range 5°C to 30°C - winter/summer selection changeover relay output NC+NO 5A (2A inductive) - 3 modules</i>		93,65	1	1

45B85SW

## Richiesta di udienza *Access request system*

	Descrizione <i>Description</i>	Info	€	□	□
	<b>45RC12BB</b> Modulo di chiamata e ricezione (posto esterno) con scritte AVANTI - ATTENDERE - OCCUPATO e segnalazione acustica - 12Vca/cc - 2 moduli <i>External access request panel with acoustic signal and Enter - Wait - Engaged display - 12Vac/dc - 2 modules</i>	•	151,99	1	1
	<b>45RC13BB</b> Modulo di ricezione e risposta (posto interno) completo di tre pulsanti per attivare le scritte AVANTI - ATTENDERE - OCCUPATO sul posto esterno - led luminosi e segnalazione acustica - 12Vca/cc - 3 moduli <i>Internal access request panel with 3 push button for Enter - Wait - Engaged - 12Vac/dc - 3 modules</i>		166,64	1	1
	<b>KITUDIENZA2</b> Kit base per sistema di richiesta d'udienza La confezione contiene: - n° 1 45RC12BB modulo di chiamata e ricezione (posto esterno) con scritte AVANTI - ATTENDERE - OCCUPATO e segnalazione acustica - 12Vca/cc; - n° 1 45RC13BB modulo di ricezione e risposta (posto interno) completo di tre pulsanti per attivare le indicazioni di AVANTI - ATTENDERE - OCCUPATO sul posto esterno, led luminosi e segnalazione acustica - 12Vca/cc; - n° 1 45B63 supporto con viti per scatola rettangolare 3 moduli; - n° 1 45TL3BMC contenitore autoportante inclinato da tavolo 3 moduli bianco Banquise (RAL9016) completo di placca color bianco Banquise micallizzato. <i>Basic Kit for access request system</i> The packet contains: - n° 1 45RC12BB external access request panel with acoustic signal and ENTER - WAIT - ENGAGED display - 12Vac/dc; - n° 1 45RC13BB internal access request panel with 3 push button for ENTER - WAIT - ENGAGED - 12Vac/dc; - n° 1 45B63 frames with screws for 3 modules rectangular boxes; - n° 1 45TL3BMC 3 modules Banquise (RAL9016) with desktop enclosure with mica-finished Banquise		321,45	1	1

45RC12BB

45RC13BB

KITUDIENZA2

◇ Prodotto per scatola quadrata  
Product for British Standard  
square box only

② Prodotto 1 modulo installabile in scatola tonda  
con altro prodotto 1 modulo  
1 module product installable in round box with  
another 1 module device

□ Imballo Minimo pcs  
Min. Packaging pcs

□ Imballo Standard pcs  
Std. Packaging pcs





**Serie Blanc** (RAL 1013)  
Blanc Series (RAL 1013)

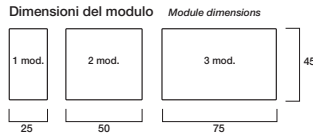

**Interruttori 250V**  
1 way switches 250V





Le dimensioni, salvo diversamente specificato, sono in mm  
Dimensions, except where otherwise specified, are in mm

**Sistema 45**

292

		Descrizione <i>Description</i>	Info	€	□	□
	45901	<b>45901</b> Interruttore 1P 16AX - con tasto intercambiabile e meccanismo soft <i>16AX 1 way single pole switch - with interchangeable cover and soft mechanism</i>	②	5,41	10	100
	45901-10	<b>45901-10</b> Interruttore 1P 10AX - con tasto intercambiabile e meccanismo soft <i>10AX 1 way single pole switch - with interchangeable cover and soft mechanism</i>	②	5,09	10	100
	45901G	<b>45901G</b> Interruttore 1P 16AX con gemma illuminabile - con tasto intercambiabile e meccanismo soft <i>16AX 1 way single pole switch with neon (optional) - with interchangeable cover and soft mechanism</i>	②	7,38	10	100
	45901R	<b>45901R</b> Interruttore 1P 16A - mezzo modulo <i>16A 1 way single pole switch - half module</i>	△	7,92	4	24
	45910	<b>45910</b> Interruttore bipolare 2P 16AX <i>16AX 1 way double pole switch</i>	②	18,46	10	100
	45973	<b>45973</b> Interruttore bipolare 2P 16A con chiave - la chiave esce solo in posizione di aperto <i>16A 1 way double pole key switch - the key exists only in open position</i>		54,96	1	10
		<b>Note:</b> ✓ a richiesta gli interruttori a chiave 45973 possono essere forniti con chiave estraibile solo in posizione di aperto ✓ gli articoli illuminabili sono forniti senza lampada di segnalazione <b>Note:</b> ✓ 45973 key switches can be supplied with key removable only in the open position upon request ✓ lightable articles are supplied without lamp				

**Deviatori 250V** 2 way switches 250V

		Descrizione <i>Description</i>	Info	€	□	□
	45902	<b>45902</b> Deviatore 1P 16AX - con tasto intercambiabile e meccanismo soft <i>16AX 2 way single pole switch - with interchangeable cover and soft mechanism</i>	②	7,22	10	100
	45902G	<b>45902G</b> Deviatore 1P 16AX con gemma illuminabile - con tasto intercambiabile e meccanismo soft <i>16AX 2 way single pole switch with neon (optional) - with interchangeable cover and soft mechanism</i>	②	9,16	10	100
	45902R	<b>45902R</b> Deviatore 1P 16A - mezzo modulo <i>16A 2 way single pole switch - half module</i>	△	9,68	4	24

**Invertitori 250V** Intermediate switches 250V

		Descrizione <i>Description</i>	Info	€	□	□
	45904	<b>45904</b> Invertitore 16AX <i>16AX intermediate switch</i>	②	21,97	10	100



Per la disponibilità contattare la rete commerciale  
For availability please contact sales dept.



Disponibilità fino ad esaurimento scorte  
Available until stock out



Prodotto 2 moduli adatto anche per scatola tonda  
2 modules product suitable for round box







Prodotto per scatola rettangolare inglese  
Product for British standard rectangular box





Prodotto per Export  
For Export only



## Pulsanti 250V Push buttons 250V

		Descrizione <i>Description</i>	Info	€	□	□
			45905 Pulsante 1P 10A NA - con tasto intercambiabile e meccanismo soft <i>10A single pole push button - with interchangeable cover and soft mechanism</i>	②	6,70	10 100
45905	45905G	45917	45905G Pulsante 1P 10A NA con gemma illuminabile con tasto intercambiabile e meccanismo soft <i>10A NO single pole push button with neon (optional) with interchangeable cover and soft mechanism</i>	②	8,52	10 100
			45917 Pulsante a tirante NA 1P 10A - con meccanismo soft <i>10A NO single pole cord switch pull to make - with soft mechanism</i>	②	20,23	1 10
45956	45988S		45956 Doppio pulsante 1P 10A NA con frecce direzionali <i>Twin NO 16A single pole push button with arrow symbols</i>		20,62	1 10
			45988S Pulsante con targhetta 1P 10A illuminabile anche per scatola tonda - 2 moduli <i>10A single pole push button with neon and name tag label - round box - 2 modules</i>	•	22,76	1 6

## Commutatori 250V Rolling blind switches 250V

		Descrizione <i>Description</i>	Info	€	□	□
			45951 Commutatore 1P 10AX con frecce e posizione OFF centrale <i>10AX rolling blind single pole switch with arrows (non retractive)</i>		22,32	1 10
45951	45953	45954	45953 Pulsante commutatore 1P 10A con frecce e posizione OFF centrale <i>10A rolling blind single pole push button with arrows (non retractive)</i>		23,69	1 10
			45954 Pulsante commutatore 2P 10A con frecce e posizione OFF centrale <i>10A rolling blind double pole push button with arrows (non retractive)</i>		27,73	1 10

## Variatori Dimmers



		Descrizione <i>Description</i>	Info	€	□	□
			45918 Regolatore di luminosità 230V 50-60 Hz per carichi resistivi da 60÷900W - non dotato di filtro EMC <i>Dimmer 230V 50-60Hz for resistive loads 60÷900W - The EMC filter is not included.</i>	△	55,87	2 2
45918	45948D		45948D Regolatore di luminosità con deviatore incorporato 230V 50-60 Hz per carichi resistivi da 100÷500W - tecnologia che garantisce la "silenziosità" <i>Dimmer 230V 50-60Hz for resistive loads 100÷500W with built-in 2 way switch. Noiseless technology</i>		63,29	1 6
			45948L Regolatore di luminosità con comando a pulsante 230V 50-60 Hz per carichi resistivi e induttivi da 60÷500W - tecnologia che garantisce la "silenziosità" <i>Push button dimmer 230V 50-60Hz for resistive and inductive loads 60÷500W leading edge dimmer. Noiseless technology</i>		69,45	1 1
45948L			<b>Nota:</b> 45918 utilizzabile solo in paesi non membri dell'Unione Europea <b>Note:</b> 45918 can be used in non - EU countries only			









**Copriforo**  
Blank insert



294

			Descrizione Description	Info	€	□	□
			<b>45908</b> Uscita Cord outlet		<b>3,39</b>	10	300
<b>45908</b>	<b>45913</b>	<b>45913R</b>	<b>45913</b> Tappo copriforo 1 modulo Blank insert 1 module		<b>1,52</b>	10	300
			<b>45913R</b> Tappo copriforo mezzo modulo Blank insert half module	△	<b>3,04</b>	8	48

**Prese di corrente standard italiano** *Italian standard socket outlets*

			Descrizione Description	Info	€	□	□
			<b>45906TS</b> Preso P11 2x10A+T - 250V - alveoli schermati P11 socket outlet 2x10A + E - 250V - shuttered	②	<b>8,05</b>	10	100
<b>45906TS</b>	<b>45906/15TS</b>		<b>45906/15TS</b> Preso bipasso P17/11 2x10/16A+T - 250V - alveoli schermati Combined socket outlet P17/11 2x10/16A + E - 250V - shuttered	②	<b>9,11</b>	10	100
			<b>45990TS</b> Preso schuko P30 2P+T 16A 250V - alveoli schermati - 2 moduli Schuko socket outlet P30 2P+E 16A 250V - shuttered - 2 modules	•	<b>15,08</b>	5	50
<b>45990TS</b>	<b>45990/15TS</b>		<b>45990/15TS</b> Preso schuko bipasso P40 2P+T 10/16A 250V - alveoli schermati - 2 moduli Combined schuko + Italian standard socket outlet 2P+E 10/16A 250V - shuttered - 2 modules	•	<b>16,67</b>	5	50

**Prese di corrente standard esteri** *Various standards socket outlets*

			Descrizione Description	Info	€	□	□
			<b>45933</b> Preso Euroamericana 2P 16A 250V Euroamerican socket outlet 2P 16A 250V	② △ 	<b>8,21</b>	10	100
<b>45933</b>			<b>Nota:</b> 45933, 45933TD utilizzabili solo in paesi non membri dell'Unione Europea <b>Note:</b> 45933, 45933TD can be used in non - EU countries only				



Per la disponibilità contattare la rete commerciale  
For availability please contact sales dept.



Disponibilità fino ad esaurimento scorte  
Available until stock out



Prodotto 2 moduli adatto anche per scatola tonda  
2 modules product suitable for round box



Prodotto per scatola rettangolare inglese  
Product for British standard rectangular box



Prodotto per Export  
For Export only

## Prese TV Satellitare - Ø 9,5 mm





### TV / SAT coaxial outlets - Ø 9,5 mm

Descrizione Description		Info	€	□	□
	<b>45996MN</b> Presa diretta con porta utente IEC maschio - permette il passaggio di corrente <i>Direct socket outlet male connector - It allows the current passage</i>	22,76	1	10	

45996MN

## Prese TV/SAT con CAP - Ø 9,5 mm - Accessori

### TV/SAT coaxial outlets with cap - Ø 9,5 mm - Accessories

Descrizione Description		Info	€	□	□
	<b>45996F</b>	15,28	1	10	
	<b>45996IM</b>				
	<b>CAP</b>	0,57	50	50	
	<b>TVDER-DB6</b> Derivatore induttivo TV/SAT ad innesto su presa 45996IM, 45996IF, 45996F - attenuazione di derivazione 7dB <i>TV/SAT inductive shunt to be connected to a socket. 45996IM, 45996IF, 45996F - attenuation 7dB</i>	10,09	1	6	
	<b>TVDER-DB10</b> Derivatore induttivo TV/SAT ad innesto su presa 45996IM, 45996IF, 45996F - attenuazione di derivazione 10dB <i>TV/SAT inductive shunt to be connected to a socket. 45996IM, 45996IF, 45996F - attenuation 10dB</i>	9,89	1	6	
	<b>TVDER-DB14</b> Derivatore induttivo TV/SAT ad innesto su presa 45996IM, 45996IF, 45996F - attenuazione di derivazione 14dB <i>TV/SAT inductive shunt to be connected to a socket. 45996IM, 45996IF, 45996F - attenuation 14dB</i>	9,89	1	6	

### Prese TV passanti

#### Through line sockets

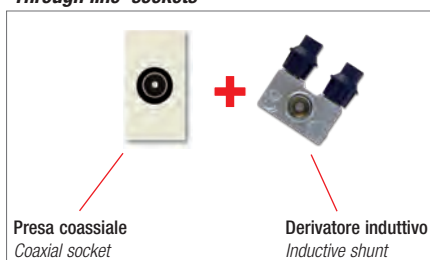

**Nota:** TVDER-DB... permettono la trasformazione delle prese 45996IM, 45996IF, 45996F da dirette a passanti  
**Note:** TVDER-DB... they allow to change the sockets 45996IM, 45996IF, 45996F from direct to through line





**Serie Blanc** (RAL 1013)

*Blanc Series (RAL 1013)*

**Prese telefoniche/dati**  
*Telephone and data socket outlets*

*Sistema 45*

296



45924



45929C5E

Descrizione Description	Info	€	□	□
<b>45924</b> Presca telefonica RJ11 4 pin - morsetti a vite <i>RJ11 Telephone socket outlet 4 pins - screw terminals</i>		<b>26,19</b>	4	24
<b>45929C5E</b> Presca di connettore 3M RJ45 CAT5 Enhanced 8 pin con morsetti ad incisione di isolante per connessioni tipo T568A o T568B <i>3M RJ45 CAT5 Enhanced 8 pins connector for T568A or T568B wiring - screwless terminals</i>		<b>33,08</b>	1	10

**Adattatori prese dati con aggancio keystone** *Data outlets adaptors with keystone clipping*



45929SC



45930SC



45332SC

Descrizione Description	Info	€	□	□
<b>45929SC</b> Adattatore per connettori RJ45 3M, AT&T, CEAM-QUBIX, KRONE, CLIPSAL, AMPHENOL, FANTON o connettori AVE RJ11, RJ45, RCA, ecc. <i>Adaptor for RJ45 3M, AT&amp;T, CEAM-QUBIX, KRONE, CLIPSAL, AMPHENOL, FANTON or AVE RJ11, RJ45, RCA, etc. connectors</i>		<b>8,35</b>	5	5
<b>45930SC</b> Adattatore per connettori RJ45 AMP, SYSTIM (AT&T), QUBIX, CLIPSAL <i>Adaptor for AMP, SYSTIM (AT&amp;T), QUBIX and CLIPSAL RJ45 connectors</i>		<b>7,15</b>	5	5
<b>45332SC</b> Adattatore per connettori RJ45 Infra+ Schneider electric - fumé <i>Adaptor for Infra+ Schneider electric RJ45 outlets - smoked colour</i>		<b>8,07</b>	5	5

**Lampada estraibile portatile** *Portable removable light*



45786BP

Descrizione Description	Info	€	□	□
<b>45786BP</b> LUCE SICURA, lampada anti black-out estraibile portatile con batterie ricaricabili e sostituibili - lampada: led bianco ad alta efficienza - 230V - 2 moduli <i>Removable anti-black out light with rechargeable and replaceable batteries - 230V - 2 modules</i>	•	<b>126,57</b>	1	6
<b>45786B</b> Batteria (4x1,2)V - 80mAh, di ricambio per 45786BP <i>Replacement battery for 45786BB (4x1,2)V - 80mAh</i>		<b>14,17</b>	1	1



Per la disponibilità contattare la rete commerciale  
For availability please contact sales dept.



Disponibilità fino ad esaurimento scorte  
Available until stock out



Prodotto 2 moduli adatto anche per scatola tonda  
2 modules product suitable for round box



Prodotto per scatola rettangolare inglese  
Product for British standard rectangular box



Prodotto per Export  
For Export only

## Segnalazioni acustiche Acoustic signals

		Descrizione Description	Info	€	□	□
 45928 45929		<b>45928</b> Suoneria squillante 12Vca 8VA <i>Ringling bell 12Vac 8VA</i>		<b>33,00</b>	1	10
		<b>45929</b> Suoneria squillante 230Vca <i>Ringling bell 230Vac</i>		<b>40,34</b>	1	10
		<b>45931</b> Ronzatore 230Vca <i>Buzzer 230Vac</i>		<b>33,88</b>	1	10

**Nota:** Utilizzare solo per servizio ad intermittenza. Tempo massimo di utilizzo continuo 5" con relativa pausa di 15"

*Note: Use only for intermittent service. Maximum time of continuous use 5 " with relative pause of 15"*

297



Sistema 45

## Rivelatori di presenza Occupancy sensors

		Descrizione Description	Info	€	□	□
 45968-500		<b>45968-500</b> LUCE AMICA - rivelatore a raggi infrarossi per accensione luci - 230V max 500W - ritardo spegnimento da 4s a 5min - sensibilità regolabile - lente con portata 11m e apertura 120° - uscita con contatto in scambio 8A (5A induttivi) - lente opzionale con portata 30m e apertura 80° <i>LUCE AMICA - Infrared detector for lighting control - 230V max 500W Adjustable off delay from 4s to 5 min approx. - adjustable light sensitivity - lens with 11m range and 120° opening - exit with switching contacts 8A (5A inductive) - optional lens with 30m range and 80° opening</i>	•	<b>168,91</b>	1	1

## Gestione della temperatura Temperature control

		Descrizione Description	Info	€	□	□
 45985SW		<b>45985SW</b> Termostato elettronico 230V - range da 5°C a 30°C - commutazione estate/inverno - uscita con contatti in scambio NC+NA 5A (2A induttivi) - 3 moduli <i>Electronic Thermostat 230V - range 5°C 30°C - winter/summer selection changeover relay output NC+NO 5A (2A inductive) - 3 modules</i>		<b>101,98</b>	1	1

◇ Prodotto per scatola quadrata  
Product for British Standard  
square box only

② Prodotto 1 modulo installabile in scatola tonda  
con altro prodotto 1 modulo  
1 module product installable in round box with  
another 1 module device

□ Imballo Minimo pcs  
Min. Packaging pcs

□ Imballo Standard pcs  
Std. Packaging pcs





# Serie RAL (RAL 7035)

## RAL Series (RAL 7035)

### Interruttori 250V

#### 1 way switches 250V

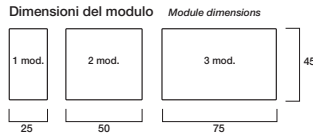

Le dimensioni, salvo diversamente specificato, sono in mm  
Dimensions, except where otherwise specified, are in mm

# Sistema 45

298



45501



45510

Descrizione <i>Description</i>	Info	€	□	□
<b>45501</b> Interruttore 1P 16AX - con meccanismo soft <i>16AX 1 way single pole switch - with soft mechanism</i>	②	<b>3,93</b>	10	100
<b>45510</b> Interruttore bipolare 2P 16AX <i>16AX 1 way double pole switch</i>	②	<b>13,79</b>	10	100

### Deviatori 250V 2 way switches 250V



45502

Descrizione <i>Description</i>	Info	€	□	□
<b>45502</b> I Deviatore 1P 16AX - con meccanismo soft <i>16AX 2 way single pole switch - with soft mechanism</i>	②	<b>5,09</b>	10	100

### Invertitori 250V Intermediate switches 250V



45504

Descrizione <i>Description</i>	Info	€	□	□
<b>45504</b> Invertitore 16AX <i>16AX intermediate switch</i>	②	<b>16,19</b>	10	100

### Pulsanti 250V Push buttons 250V



45505



45505G



45517

Descrizione <i>Description</i>	Info	€	□	□
<b>45505</b> Pulsante 1P 10A NA - con meccanismo soft <i>10A single pole push button - with soft mechanism</i>	②	<b>5,25</b>	10	100
<b>45505G</b> Pulsante 1P 10A NA con gemma illuminabile - con meccanismo soft <i>10A NO single pole push button with neon (optional) - with soft mechanism</i>	②	<b>7,22</b>	10	100
<b>45517</b> Pulsante a tirante NA 1P 10A <i>10A NO single pole cord switch pull to make</i>	②	<b>15,75</b>	1	10

### Commutatori 250V Rolling blind switches 250V



45552  
45554

Descrizione <i>Description</i>	Info	€	□	□
<b>45552</b> Commutatore 2P 10AX con frecce e posizione OFF centrale <i>10AX rolling blind double pole switch with arrows (non retractive)</i>		<b>22,04</b>	1	10
<b>45554</b> Pulsante commutatore 2P 10A con frecce e posizione OFF centrale <i>10A rolling blind double pole push button with arrows (retractive)</i>		<b>20,97</b>	1	10



Per la disponibilità contattare la rete commerciale  
For availability please contact sales dept.



Disponibilità fino ad esaurimento scorte  
Available until stock out



Prodotto 2 moduli adatto anche per scatola tonda  
2 modules product suitable for round box





Prodotto per scatola rettangolare inglese  
Product for British standard rectangular box





Prodotto per Export  
For Export only



## Copriforo Blank insert

		Descrizione Description	Info	€	□	□
		<b>45508</b> Uscita Cord outlet		<b>3,10</b>	5	5
<b>45508</b>	<b>45513</b>	<b>45513</b> Tappo copriforo 1 modulo Blank insert 1 module		<b>1,17</b>	10	300



## Prese di corrente standard italiano Italian standard socket outlets

		Descrizione Description	Info	€	□	□
		<b>45506/15TS</b> Presa bipasso P17/11 2x10/16A+T - 250V - alveoli schermati Combined P17/11 2x10/16A + E - 250V - shuttered	②	<b>6,93</b>	10	100
<b>45506/15TS</b>		<b>45590TS</b> Presa P30 UNEL 2P+T 16A 250V - alveoli schermati - 2 moduli Schuko socket outlet 2P+E 16A 250V - shuttered - 2 modules	•	<b>11,42</b>	5	50
		<b>45590/15TS</b> Presa P40 UNEL bipasso 2P+T 10/16A 250V - alveoli schermati - 2 moduli Combined schuko + Italian standard socket outlet 2P+E 10/16A 250V - shuttered - 2 modules	•	<b>13,32</b>	5	50
<b>45590TS</b>	<b>45590/15TS</b>					

## Prese di corrente standard esteri Various standards socket outlets

		Descrizione Description	Info	€	□	□
		<b>45592TS</b> Presa standard francese 2P+T 16A 250V - alveoli schermati - 2 moduli French standard socket 2P+E 16A 250V - shuttered - 2 modules	☎ • Δ	<b>10,33</b>	5	50
<b>45592TS</b>	<b>45597TS</b>	<b>45597TS</b> Presa standard BS1363 2P+T 13A 250V - alveoli schermati - 2 moduli British standard socket outlet BS1363 2P+E 13A 250V - shuttered - 2 modules	☎ • Δ	<b>15,20</b>	5	50
		<b>Nota:</b> 45533, 45592S utilizzabili solo in paesi non membri dell'Unione Europea <b>Note:</b> 45533, 45592S can be used in non - EU countries only				

## Segnalazioni acustiche Acoustic signals

		Descrizione Description	Info	€	□	□
		<b>45528</b> Suoneria squillante 12Vca 8VA Ringing bell 12Vac 8VA		<b>25,89</b>	1	10
<b>45528</b>	<b>45530</b>	<b>45530</b> Ronzatore 12Vca 8VA Buzzer 12Vac 8VA		<b>19,55</b>	1	10
		<b>Nota:</b> Utilizzare solo per servizio ad intermittenza. Tempo massimo di utilizzo continuo 5" con relativa pausa di 15" <b>Note:</b> Use only for intermittent service. Maximum time of continuous use 5 " with relative pause of 15"				

◇ Prodotto per scatola quadrata  
Product for British Standard  
square box only

② Prodotto 1 modulo installabile in scatola tonda  
con altro prodotto 1 modulo  
1 module product installable in round box with  
another 1 module device

□ Imballo Minimo pcs  
Min. Packaging pcs

□ Imballo Standard pcs  
Std. Packaging pcs

299





Sistema 45



**Prese TV/SAT con CAP - Ø 9,5 mm - Accessori**  
TV/SAT coaxial outlets with cap - Ø 9,5 mm - Accessories

300

	Descrizione <i>Description</i>	Info	€	□	□
 45596IM	<b>45596IM</b> Presse coassiale con porta utente IEC maschio per frequenze fino a 2400 MHz - collegamento in ingresso mediante connettore maschio tipo F - fornita con connettore plastico (CAP) per la connessione 2400 MHz IEC male coaxial socket. Incoming connection with male F-type connector <i>Supplied with moulded connector (CAP) for coaxial cable connection</i>		12,37	1	10
	<b>CAP</b> Connettore plastico per cavi coassiali - consente una connessione rapida ed economica - da utilizzare con prese 45596IM <i>Moulded connector for coaxial cables to be used with 45596IM sockets</i>		0,57	50	50
 CAP	<b>TVDER-DB6</b> Derivatore induttivo TV/SAT ad innesto su presa 45596IM - attenuazione di derivazione 7dB <i>TV/SAT inductive shunt to be connected to a socket. 45596IM - attenuation 7dB</i>		10,09	1	6
 TVDER-DB6 TVDER-DB10 TVDER-DB14	<b>TVDER-DB10</b> Derivatore induttivo TV/SAT ad innesto su presa 45596IM - attenuazione di derivazione 10dB <i>TV/SAT inductive shunt to be connected to a socket. 45596IM - attenuation 10dB</i>		9,89	1	6
	<b>TVDER-DB14</b> Derivatore induttivo TV/SAT ad innesto su presa 45596IM - attenuazione di derivazione 14dB <i>TV/SAT inductive shunt to be connected to a socket. 45596IM - attenuation 14dB</i>		9,89	1	6

**Presse telefonica Telephone outlet**

	Descrizione <i>Description</i>	Info	€	□	□
 45524	<b>45524</b> Presse telefonica RJ11 4 pin - morsetti a vite <i>RJ11 Telephone socket outlet 4 pins- screw terminals</i>		18,96	4	24

**Comandi industriali 250V Industrial controls 250V**

	Descrizione <i>Description</i>	Info	€	□	□
 45401C-GR	<b>45401C-GR</b> Commutatore rotativo 1-0-2 - 1P 10A - fornito con n. 1 contatto NA <i>10A single pole rotative changeover switch 1-0-2 - supplied with 1 NO contact</i>	•	23,07	2	2

**Note:** ✓ a richiesta, per quantitativi minimi di 50 pz., possono essere forniti con mostrina NOIR  
**Note:** ✓ NOIR cover upon request, minimum order 50 pcs.



Per la disponibilità contattare la rete commerciale  
For availability please contact sales dept.



Disponibilità fino ad esaurimento scorte  
Available until stock out



Prodotto 2 moduli adatto anche per scatola tonda  
2 modules product suitable for round box



Prodotto per scatola rettangolare inglese  
Product for British standard rectangular box



Prodotto per Export  
For Export only

## Accessori comuni a tutte le serie

Common accessories for all series



### Comandi e quadretto

Controls and Emergency panel

	Descrizione <i>Description</i>	Info	€	□	□
 <b>45Q20N</b>	<b>45Q20N</b> Quadretto con chiavistello e vetro frangibile per comando di emergenza capacità 2 mod. Sistema 45 - RAL 7035 - installazione su scatola rettangolare 3 moduli cod. 2503MG <i>Emergency control panel with door latch and breakable glass capacity 2 mod. - to be installed on 3 modules rectangular box code 2503MG</i>		<b>24,23</b>	1	6
	<b>45105R</b> Pulsante di emergenza rosso 1P 10A NA+NC - 2 moduli <i>1P 10A emergency pushbutton NO+NC - red - 2 modules</i>	•	<b>14,12</b>	1	6

301





Sistema 45



45105R

### Prese di corrente per linee dedicate *Socket outlets for dedicated circuits*

	Descrizione <i>Description</i>	Info	€	□	□
 <b>45B06/15TSR</b>	<b>45B06/15TSR</b> Presa 2x10/16A+T - 250V - alveoli schermati - rossa - 1 modulo <i>2x10/16A + E - 250V - shuttered - red - 1 module</i>	②	<b>8,69</b>	10	100
	<b>45B90TSR</b> Presa schuko P30 2P+T 16A 250V - alveoli schermati - rossa - 2 moduli <i>Schuko P30 2P+E 16A 250V - shuttered - red - 2 modules</i>	•	<b>12,87</b>	5	50
 <b>45B90/15TSR</b>	<b>45B90/15TSR</b> Presa schuko bipasso P402P+T 10/16A 250V - alveoli schermati - rossa - 2 moduli <i>Combined schuko + Italian standard socket outlet 2P+E 10/16A 250V shuttered - red - 2 modules</i>	•	<b>14,04</b>	5	50
	 <b>45B90/15TSV</b> Presa schuko bipasso P40 2P+T 10/16A 250V - alveoli schermati - verde - 2 moduli <i>Combined schuko + Italian standard socket outlet 2P+E 10/16A 250V shuttered - green - 2 modules</i>	•	<b>14,04</b>	5	50

45B90TSR

45B90/15TSR

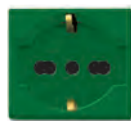

45B90/15TSV

◊ Prodotto per scatola quadrata  
Product for British Standard  
square box only

② Prodotto 1 modulo installabile in scatola tonda  
con altro prodotto 1 modulo  
1 module product installable in round box with  
another 1 module device

□ Imballo Minimo pcs  
Min. Packaging pcs

□ Imballo Standard pcs  
Std. Packaging pcs



# Accessori comuni a tutte le serie

Common accessories for all series

Sistema 45

## Connettori di Segnale Connectors

302



CBNCF



CHDMI



CRCAF



CRCAF/GI



CRCAF/RS



CRJ11T



CRJ45C5E



CTVF



CTVIF

### Descrizione Description

Info

€

□

□

#### CBNCF

8,46 2 2

Connettore AVE BNC femmina - collegamento in ingresso mediante connettore maschio tipo F - per connessioni video in bassa frequenza - utilizzo tipico per collegamento TVCC e decoder - fornito con connettore plastico (CAP) per la connessione - installabile su adattatore cod. 45929SC

*AVE BNC female connector - input connection through F-type male connector - for low frequency video connections - typical use for TVCC and decoder connections - supplied with (CAP) plastic connector - installable on adapter code 45929SC*

#### CHDMI

15,78 2 2

Connettore AVE HDMI femmina - collegamento in ingresso mediante connettore HDMI maschio - per connessioni video di alta qualità - utilizzo tipico con apparecchiature dotate di standard HDMI - installabile su adattatore cod. 45929SC

*AVE HDMI female connector - input connection through F-type male connector - for high quality video connections - typical use with HDMI standard devices - installable on adapter code 45929SC*

#### CRCAF

7,34 5 5

Connettore AVE RCA femmina - collegamento in ingresso mediante connettore maschio tipo F - per connessioni audio in bassa frequenza - utilizzo tipico per collegamento altoparlanti - fornito con connettore plastico (CAP) per la connessione - installabile su adattatore cod. 45929SC

*AVE RCA female connector - input connection through F-type male connector - for low frequency audio connections - typical use for loudspeaker connections - supplied with (CAP) plastic connector - installable on adapter code 45929SC*

#### CRCAF/GI

7,44 5 5

Come sopra ma con dielettrico di colore giallo per distinzione del canale audio  
*As above with dielectric in yellow colour for the audio channel distinction*

#### CRCAF/RS

7,44 5 5

Come sopra ma con dielettrico di colore rosso per distinzione del canale audio  
*As above with dielectric in red colour for the audio channel distinction*

#### CRJ11T

8,46 5 5

Connettore AVE RJ11 (4 contatti) - morsetti ad incisione d'isolante con cablaggio rapido - installabile su adattatore cod. 45929SC

*AVE RJ11 connector (4 contacts) - insulation piercing terminals with quick wiring - installable on adapter code 45929SC*

#### CRJ45C5E

9,38 2 2

Connettore AVE RJ45 categoria 5 enhanced - non schermato - morsetti ad incisione d'isolante - cablaggio rapido tramite accessorio fornito in dotazione - cablaggio universale T568A e T568B - 8 contatti - installabile su adattatore cod. 45929SC

*AVE RJ45 category 5 enhanced connector - unshielded - insulation piercing terminals - supplied with accessory for quick wiring - T568A and T568B universal wiring - 8 contacts - installable on adapter code 45929SC*

#### CTVF

5,72 5 5

Connettore AVE TV/SAT tipo F femmina - collegamento in ingresso mediante connettore maschio tipo F - utilizzo tipico per collegamenti SAT- fornito con connettore plastico (CAP) per la connessione - installabile su adattatore cod. 45929SC

*AVE TV/SAT female type F connector - typical use for SAT connections - supplied with plastic connector (CAP) for the installation - installable on adapter code 45929SC*

#### CTVIF

5,72 5 5

Connettore AVE TV/FM IEC femmina - collegamento in ingresso mediante connettore maschio tipo F - utilizzo tipico per collegamenti FM- fornito con connettore plastico (CAP) per la connessione - installabile su adattatore cod. 45929SC

*AVE TV/SAT IEC male connector - input connection through male connector type F - typical use for TV connections - supplied with plastic connector (CAP) for the installation - installable on adapter code 45929SC*



Per la disponibilità contattare la rete commerciale  
For availability please contact sales dept.



Disponibilità fino ad esaurimento scorte  
Available until stock out



Prodotto 2 moduli adatto anche per scatola tonda  
2 modules product suitable for round box





Prodotto per scatola rettangolare inglese  
Product for British standard rectangular box



Prodotto per Export  
For Export only

## Connettori di Segnale Connectors

	Descrizione <i>Description</i>	Info	€	□	□
 <b>CTVIM</b>	<b>CTVIM</b> Connettore AVE TV/SAT IEC maschio - collegamento in ingresso mediante connettore maschio tipo F - utilizzo tipico per collegamenti TV digitale terrestre - fornito con connettore plastico (CAP) per la connessione - installabile su adattatore cod. 45929SC <i>AVE TV/SAT IEC male connector - input connection through male connector type F - typical use for TV connections - supplied with plastic connector (CAP) for the installation - installable on adapter code 45929SC</i>		5,72	5	5
 <b>CUSB</b>	<b>CUSB</b> Connettore AVE USB femmina - collegamento in ingresso mediante connettore USB maschio - per connessioni dati ad apparecchiature dotate di standard USB - installabile su adattatore cod. 45929SC <i>AVE USB female connector - input connection through USB male connector - for devices with USB standard - installable on adapter code 45929SC</i>		9,16	5	5

303



Sistema 45

### Connettori di Segnale Ave *Ave Connectors*



Tutti i connettori si installano su un unico adattatore cod. 45329SC  
*All the connectors can be installed on a single adaptor - code 45329SC*

Aggancio connettore ad adattatore  
*Connector clipping to the adaptor*

◇ Prodotto per scatola quadrata  
 Product for British Standard square box only

② Prodotto 1 modulo installabile in scatola tonda con altro prodotto 1 modulo  
 1 module product installable in round box with another 1 module device

□ Imballo Minimo pcs  
 Min. Packaging pcs

□ Imballo Standard pcs  
 Std. Packaging pcs





## Accessori comuni

Common accessories

Ampliamento S45 con frutti S44  
S44 accessories available for S45

304

Caratteristiche Tecniche Technical Features

### Supporti bivalenti Bivalent frames

2 moduli 2 modules



44A/45B2

3 moduli 3 modules



44A/45B



44A/45BP

### Frutti Sistema 44 System 44 devices



Igrostato  
Hygrostat



Regolatore di velocità  
Speed controller



Sirena da interni rossa  
Indoor red siren



Spie sporgenti  
Prominent lampholder



Spie di segnalazione  
Signaling lamps

### Placche Sistema 45 System 45 front plates



Placche "Yes 45"  
"Yes 45" front plates



Placche "Ral 45"  
"Ral 45" front plates



Placche "Yes 45"  
"Yes 45" front plates

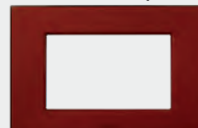

Placche "Spring"  
"Spring" front plates



Placche "Zama 45"  
"Zama 45" front plates



Placche "Banquise"  
"Banquise" front plates

### Soluzione finale Final solution



Per la disponibilità contattare  
la rete commerciale  
For availability please contact  
sales dept.



Disponibilità fino ad  
esaurimento scorte  
Available until stock out



Prodotto 2 moduli adatto  
anche per scatola tonda  
2 modules product suitable  
for round box









Prodotto per scatola  
rettangolare inglese  
Product for British standard  
rectangular box



Prodotto  
per Export  
For Export  
only

## Segnalazioni ottiche

### Optical Signals

		Descrizione Description	Info	€	□	□
		<b>45337RS</b> Spia di segnalazione rossa per lampade 0212-0224-0220-0230-0230LDB-0230LDW-0230LDR <i>Lampholder for lamps 0212-0224-0220-0230-0230LDB-0230LDW-0230LDR - red colour</i>		9,55	1	10
<b>45337RS</b>	<b>45337TR</b>	<b>45337TR</b> Spia di segnalazione trasparente per lampade 0212-0224-0220-0230-0230LDB-0230LDW-0230LDR <i>Lampholder for lamps 0212-0224-0220-0230-0230LDB-0230LDW-0230LDR - transparent</i>		9,55	1	10
		<b>45367</b> Doppia spia di segnalazione per lampade 0212-0224-0220-0230-0230LDB-0230LDW-0230LDR <i>Twin lampholder for lamps 0212-0224-0220-0230-0230LDB-0230LDW-0230LDR green/red colours</i>		12,77	1	10
<b>45367</b>	<b>45376</b>	<b>45376</b> Spia di segnalazione fuori porta rossa per lampade 0212-0224-0220-0230-0230LDB-0230LDW-0230LDR <i>Lampholder with pyramidal lens for lamps 0212-0224-0220-0230-0230LDB-0230LDW-0230LDR - red colour</i>		11,89	1	10
		<b>0212</b> Lampada ad incandescenza 6/12V~ long life - colore bianco <i>Long life incandescent lamp 6/12Vac - long life - white colour</i>		4,03	10	10
<b>0212</b>		<b>0212LDB</b> Lampada a led 12-24Vcc/ca a basso consumo - colore blu <i>Low consumption 12-24Vcc/ac led lamp - blue colour</i>		4,08	10	10
<b>0224</b>		<b>0212LDW</b> Lampada a led 12-24Vcc/ca a basso consumo - colore bianco <i>Low consumption 12-24Vcc/ac led lamp - white colour</i>		4,08	10	10
<b>0220</b>		<b>0212LDR</b> Lampada a led 12-24Vcc/ca a basso consumo - colore rosso <i>Low consumption 12-24Vcc/ac led lamp - red colour</i>		4,08	10	10
<b>0230</b>		<b>0220</b> Lampada al neon 230Vca long life - colore bianco <i>Long life neon lamp 230Vac - long life - white colour</i>		4,03	10	10
		<b>0224</b> Lampada ad incandescenza 12/24Vca long life - colore bianco <i>Long life incandescent lamp 12/24Vac - white colour</i>		4,03	10	10
<b>0212LDW</b>		<b>0230</b> Lampada fluorescente 230/380Vca long life - colore verde <i>Long life neon lamp 230/380Vac - green colour</i>		4,03	5	5
<b>0230LDR</b>		<b>0230LDB</b> Lampada a led 230V~ a basso consumo - colore blu <i>Low consumption 230V~ led lamp - blue colour</i>		4,41	10	10
<b>0230LDW</b>		<b>0230LDW</b> Lampada a led 230V~ a basso consumo - colore bianco <i>Low consumption 230V~ led lamp - white colour</i>		4,41	10	10
<b>0230LDR</b>		<b>0230LDR</b> Lampada a led 230V~ a basso consumo - colore rosso <i>Low consumption 230V~ led lamp - red colour</i>		4,41	10	10

### Ampliamento S45 con accessori S44

*S44 accessories available for S45*



**442076**

**442076VE**



**44A/45B**

<b>442076</b> Spia di segnalazione sporgente (fuoriporta) con diffusore rosso - per lampade con attacco E10 10x28 mm 230V~ 3W max - 2 moduli <i>Prominent lampholder (outside door) with red diffuser - for E10 10x28 mm 230V~ 3W max lamps - 2 modules</i>	19,22	1	6
<b>442076VE</b> Spia di segnalazione sporgente (fuoriporta) con diffusore verde - per lampade con attacco E10 10x28 mm 230V~ 3W max - 2 moduli <i>Prominent lampholder (outside door) with green diffuser - for E10 10x28 mm 230V~ 3W max lamps - 2 modules</i>	19,22	1	1
<b>44A/45B</b> Supporto 3 moduli per placche S45 - colore bianco RAL 9010 - per scatole 2503MG, 253CG - con viti <i>3 modules frame for S45 front plates - RAL 9010 white colour - for 2503MG, 253CG boxes - with screws</i>	2,46	10	10
<b>44A/45BP</b> Supporto 3 moduli per placche S45 - colore avorio RAL 1013 - per scatole 2503MG, 253CG - con viti <i>3 modules frame for S45 front plates - RAL 1013 ivory colour - for 2503MG, 253CG boxes - with screws</i>	2,46	10	10
<b>44A/45B2</b> Supporto 1-2 moduli per placche rettangolari S45 1 o 2 moduli centrali - colore bianco RAL 9010 - per scatole 2503MG, 253CG e per scatole tonde o quadrate con interasse 60 mm o 56x56 mm - con viti <i>1-2 modules frame for S45 rectangular front plates with 1 or 2 central modules - colour RAL 9010 white - for 2503MG, 253CG boxes and round or square boxes with centre distance of 60 mm or 56x56 mm - with screws</i>	2,50	10	10

**Nota:** 0212 alimentata con tensione 12V~ ha una durata limitata a 2.000 ore

*Note:* 0212 12V~ powered 2.000 hours endurance



# Placche delle Serie Civili

## Sistema 45

### System 45

Wiring Accessories front plates



**Design:**

A. Van Onck  
M. Hasuike  
H.M.R.  
B. Dall'Eco  
L. Merletti

**Indice**  
**Index**

Placche  
Banquise 45  
VBanquise 45 front plates

**308**



Placche  
Zama 45  
Zama 45 front plates

**310**



Placche  
RAL 45  
RAL 45 front plates

**313**



Placche  
Yes 45  
Yes 45 front plates

**317**



Placche  
Blanc 45  
Blanc 45 front plates

**323**





# Placche

## Front Plates

# Sistema 45

Placche in metallo "Banquise" con inserto illuminabile per scatola rettangolare  
 "Banquise" metal front plates with lightable insert for rectangular boxes

Design:  
M. Hasuike

308

3 MODULI / 3 MODULES

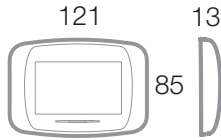

Armatura da utilizzare  
To be used with



45B63

Cod. Code	Descrizione Description	Info	€	□	□
45PB93AO	Argento opaco Matt silver	21,27	1	15	
45PB93BMC	Bianco Banquise micalizzato Mica-finished Banquise white	20,85	1	15	
45PB93GSM	Grigio scuro metallizzato Metallic dark grey	20,85	1	15	
45PB93NC	Nichel Nickel	31,73	1	15	
45PB93NCS	Nichel spazzolato Brushed nickel	31,73	1	15	
45PB93OT	Ottone lucido Polished brass	31,73	1	15	

4 MODULI / 4 MODULES

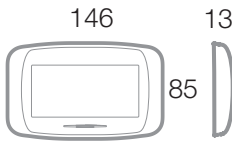

Armatura da utilizzare  
To be used with



45764

Cod. Code	Descrizione Description	Info	€	□	□
45PB94AO	Argento opaco Matt silver	28,35	1	14	
45PB94BMC	Bianco Banquise micalizzato Mica-finished Banquise white	28,35	1	14	
45PB94GSM	Grigio scuro metallizzato Metallic dark grey	28,35	1	14	
45PB94NC	Nichel Nickel	37,97	1	14	
45PB94OT	Ottone lucido Polished brass	41,27	1	14	

6 MODULI / 6 MODULES

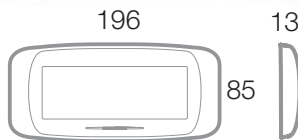

Armatura da utilizzare  
To be used with



45366

Cod. Code	Descrizione Description	Info	€	□	□
45PB96AO	Argento opaco Matt silver	36,28	1	10	
45PB96BMC	Bianco Banquise micalizzato Mica-finished Banquise white	36,28	1	10	
45PB96CR	Cromo Chrome	47,80	1	10	
45PB96GSM	Grigio scuro metallizzato Metallic dark grey	37,91	1	10	
45PB96NC	Nichel Nickel	47,80	1	10	
45PB96NCS	Nichel spazzolato Brushed nickel	47,80	1	10	
45PB96OT	Ottone lucido Polished brass	54,83	1	10	



Per la disponibilità contattare  
la rete commerciale  
For availability please contact  
sales dept.



Disponibilità fino ad  
esaurimento scorte  
Available until stock out



Prodotto 2 moduli adatto  
anche per scatola tonda  
2 modules product suitable  
for round box



Prodotto per scatola  
rettangolare inglese  
Product for British standard  
rectangular box



Prodotto  
per Export  
For Export  
only

## Placche in tecnopolimero "Banquise" per scatola rettangolare "Banquise" moulded front plates for rectangular boxes

Design:  
M. Hasuike

3 MODULI / 3 MODULES		Cod. Code	Descrizione Description	Info	€	□	□
	45PB03BB	Bianco Banquise (RAL 9016) <i>Banquise white (RAL 9016)</i>	5,19	1	25		
	45PB03BP	Bianco Blanc (RAL 1013) <i>Blanc white (RAL 1013)</i>	5,19	1	25		
	45PB03GSM	Grigio scuro metallizzato <i>Metallic dark grey</i>	9,61	1	25		
	45PB03NL	Nero lucido <i>Polished black</i>	5,19	1	25		

45PB03BB



Armatura da utilizzare  
To be used with



45B63

309



Sistema 45

## Placche in tecnopolimero "Banquise" per scatola rettangolare "Banquise" moulded front plates for rectangular boxes

4 MODULI / 4 MODULES		Cod. Code	Descrizione Description	Info	€	□	□
	45PB04BB	Bianco Banquise (RAL 9016) <i>Banquise white (RAL 9016)</i>	7,63	1	20		
	45PB04BP	Bianco Blanc (RAL 1013) <i>Blanc white (RAL 1013)</i>	7,63	1	20		
	45PB04GSM	Grigio scuro metallizzato <i>Metallic dark grey</i>	13,49	1	20		
	45PB04NL	Nero lucido <i>Polished black</i>	7,63	1	20		

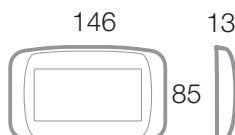

Armatura da utilizzare  
To be used with



45764

## Placche in tecnopolimero "Banquise" per scatola rettangolare "Banquise" moulded front plates for rectangular boxes

6 MODULI / 6 MODULES		Cod. Code	Descrizione Description	Info	€	□	□
	45PB06BB	Bianco Banquise (RAL 9016) <i>Banquise white (RAL 9016)</i>	11,32	1	15		
	45PB06BP	Bianco Blanc (RAL 1013) <i>Blanc white (RAL 1013)</i>	11,32	1	15		
	45PB06GSM	Grigio scuro metallizzato <i>Metallic dark grey</i>	15,84	1	15		
	45PB06NL	Nero lucido <i>Polished black</i>	11,32	1	15		

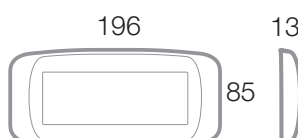

Armatura da utilizzare  
To be used with



45366

Le dimensioni, salvo diversamente specificato, sono in mm  
Dimensions, except where otherwise specified, are in mm

◆ Prodotto per scatola quadrata  
Product for British Standard  
square box only

② Prodotto 1 modulo installabile in scatola tonda  
con altro prodotto 1 modulo  
1 module product installable in round box with  
another 1 module device

□ Imballo Minimo pcs  
Min. Packaging pcs

□ Imballo Standard pcs  
Std. Packaging pcs





# Placche

## Front Plates

# Sistema 45

### Placche in metallo "Zama 45" per scatola rettangolare

"Zama 45" metal front plates for rectangular boxes

Design:  
M. Hasuike

310

3 MODULI / 3 MODULES



45P93AM

45P93BG



45P93BP

45P93CR



45P93GSM

45P93BMC



45P93NL

45P93TI

Cod. Code	Descrizione Description	Info	€	□	□
45P93AM	Argento metallizzato Metallic silver		20,20	1	15
45P93BG	Bianco Banquise (RAL 9016) Banquise white (RAL 9016)		19,55	1	15
45P93BMC	Bianco Banquise micalizzato Mica-finished Banquise white		20,20	1	15
45P93BP	Bianco Blanc (RAL 1013) Blanc white (RAL 1013)		19,55	1	15
45P93CR	Cromo Chrome		29,71	1	15
45P93GSM	Grigio scuro metallizzato Metallic dark grey		20,20	1	15
45P93NL	Nero lucido Polished black		20,20	1	15
45P93TI	Titanio Titanium		22,65	1	15

Armatura da utilizzare  
To be used with

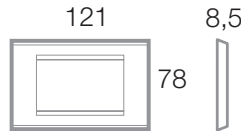

45B63

### Placche in metallo "Zama 45" per scatola rettangolare

"Zama 45" metal front plates for rectangular boxes

4 MODULI / 4 MODULES

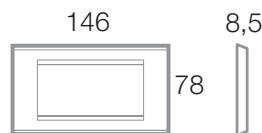

Armatura da utilizzare  
To be used with



45764

Cod. Code	Descrizione Description	Info	€	□	□
45P94AM	Argento metallizzato Metallic silver		28,91	1	14
45P94BG	Bianco Banquise (RAL 9016) Banquise white (RAL 9016)		27,48	1	14
45P94BP	Bianco Blanc (RAL 1013) Blanc white (RAL 1013)		28,91	1	14
45P94CR	Cromo Chrome		38,36	1	14
45P94GSM	Grigio scuro metallizzato Metallic dark grey		28,91	1	14
45P94TI	Titanio Titanium		30,86	1	14



Per la disponibilità contattare  
la rete commerciale  
For availability please contact  
sales dept.



Disponibilità fino ad  
esaurimento scorte  
Available until stock out



Prodotto 2 moduli adatto  
anche per scatola tonda  
2 modules product suitable  
for round box



Prodotto per scatola  
rettangolare inglese  
Product for British standard  
rectangular box



Prodotto  
per Export  
For Export  
only



## Placche in metallo "Zama 45" per scatola rettangolare

### "Zama 45" metal front plates for rectangular boxes

Design:  
M. Hasuike

6 MODULI / 6 MODULES	Cod. Code	Descrizione Description	Info	€	□	□
  <b>Armatura da utilizzare</b> <i>To be used with</i>  <b>45366</b>	45P96AM	Argento metallizzato <i>Metallic silver</i>		38,67	1	10
	45P96BG	Bianco Banquise (RAL 9016) <i>Banquise white (RAL 9016)</i>		38,67	1	10
	45P96CR	Cromo <i>Chrome</i>		51,75	1	10
	45P96GSM	Grigio scuro metallizzato <i>Metallic dark grey</i>		38,67	1	10
	45P96NL	Nero lucido <i>Polished black</i>		38,67	1	10
	45P96TI	Titanio <i>Titanium</i>		38,67	1	10
	45P96TT	Ottone lucido <i>Polished brass</i>		52,18	1	10

**Nota:** 45P96TT base in Zama come per tutti gli altri colori  
*Note: 45P96TT Zama base as all the other colours*

### Placche "antisalinità"

L'installazione in ambienti soggetti all'influenza del mare (ad esempio le imbarcazioni) o con presenza di soluzioni saline, può provocare, alle normali placche, un precoce deterioramento della verniciatura. Per ovviare a questo problema Ave ha inserito le "placche antisalinità" che, grazie ad un rivoluzionario processo di verniciatura, garantiscono una maggior resistenza nel tempo alla finitura originale. Ave offre la possibilità di avere questo trattamento solo sulle seguenti 5 colorazioni: bianco Banquise (BG), bianco Blanc (BP), cromo (CR), ottone (TT), radica (RD). Modalità di ordinazione: indicare nell'ordine, dopo il codice della placca desiderata, "con trattamento antisalinità".

### Anti-salinity front plates

The installation in environments close to the sea (for example the boats) or where salt solutions are present, can cause a premature deterioration of the paint in normal kind of front plates. In order to solve this problem, Ave proposes the anti-salinity front plates: thanks to a revolutionary process of paint, they guarantee a greater resistance through the time. Ave can offer this special paint in the following colours: Banquise white (BG), Blanc white (BP), Chrome (CR), Brass (TT), Briarwood (RD). How to order them: indicate on your purchase order "with anti-salinity treatment" after the front plate code.



## Placche in metallo MAXIMODULO "Zama 45"

### "Zama 45" MAXI MODULE metal front plates

Cod. Code	Descrizione Description	Info	€	□	□
45P010BG	Bianco Banquise (RAL 9016) <i>Banquise white (RAL 9016)</i>		25,33	1	5



45P010...

**Armatura da utilizzare**  
*To be used with*



45760/15

**Armatura da utilizzare**  
*To be used with*



45760/10

Le dimensioni, salvo diversamente specificato, sono in mm  
 Dimensions, except where otherwise specified, are in mm

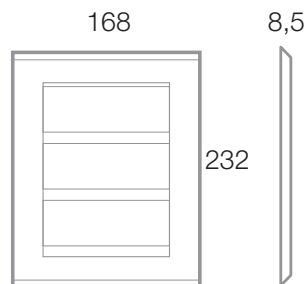
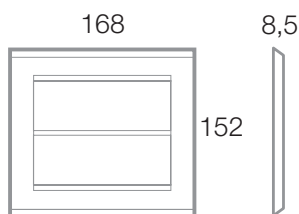

◇ Prodotto per scatola quadrata  
 Product for British Standard square box only

② Prodotto 1 modulo installabile in scatola tonda con altro prodotto 1 modulo  
 1 module product installable in round box with another 1 module device

□ Imballo Minimo pcs  
 Min. Packaging pcs

□ Imballo Standard pcs  
 Std. Packaging pcs

311



Sistema 45



# Placche

## Front Plates

# Sistema 45

### Placche in metallo "antivandalo" per scatole rettangolari

#### "Anti-vandal" metal front plates for rectangular boxes

Design:  
M. Hasuike

312

	Cod. Code	Descrizione Description	Info	€	□	□
	45P93TIAV	Placca "antivandalo" 3 moduli - fissaggio all'armatura con viti speciali che non permettono il distacco della placca se non con l'utilizzo di un apposito attrezzo - fornita con armatura speciale - colore titanio "Anti-vandal" front plate 3 modules - particular fixing system to the frame with special screws that do not allow to remove the plate except by an appropriate tool - provided with special frame - brushed nickel colour		38,45	1	1
	45P94TIAV	Placca "antivandalo" 4 moduli - fissaggio all'armatura con viti speciali che non permettono il distacco della placca se non con l'utilizzo di un apposito attrezzo - fornita con armatura speciale - colore titanio "Anti-vandal" front plate 4 modules - particular fixing system to the frame with special screws that do not allow to remove the plate except by an appropriate tool - provided with special frame - titanium colour		39,37	1	1

**Nota:** fornite con armatura speciale  
**Note:** supplied with special frame



### Sequenza installativa Installation

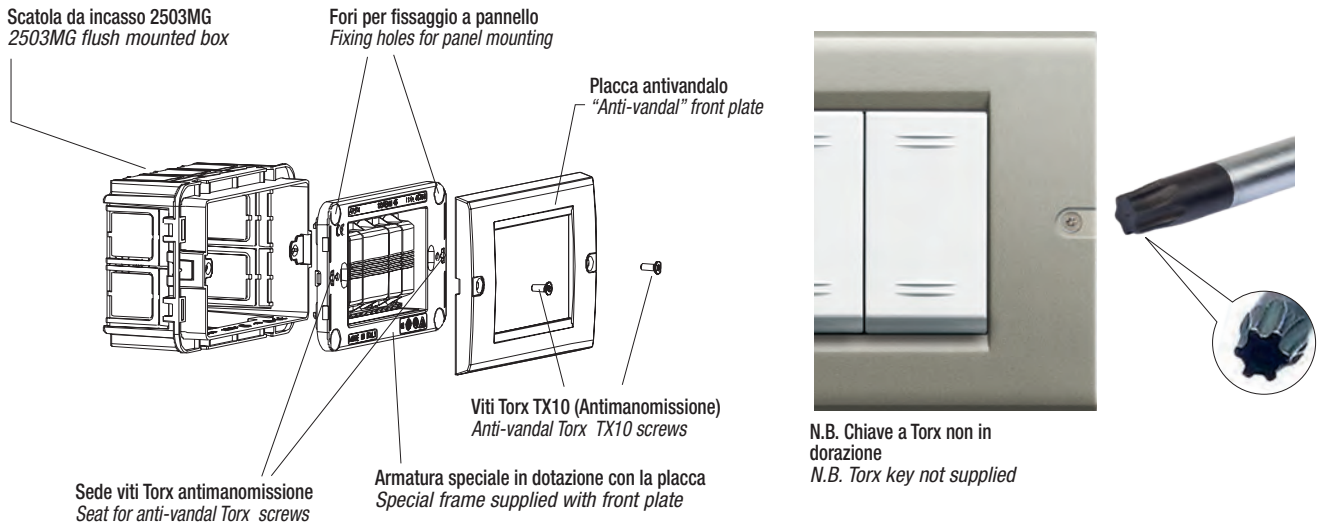

### Accessori Accessories

	Cod. Code	Descrizione Description	Info	€	□	□
	25GS	Ganci metallici di ricambio per scatole porta frutti 3 e 4 moduli Spare metallic hooks for 3 and 4 modules boxes		5,54	10	10



Per la disponibilità contattare la rete commerciale  
For availability please contact sales dept.



Disponibilità fino ad esaurimento scorte  
Available until stock out



Prodotto 2 moduli adatto anche per scatola tonda  
2 modules product suitable for round box



Prodotto per scatola rettangolare inglese  
Product for British standard rectangular box



Prodotto per Export  
For Export only

## Placche in tecnopolimero "Ral 45" sabbiate "Ral 45" matt finish moulded front plates

Design:  
H. M. R.

313

1 MODULO / 1 MODULE



Cod. Code	Descrizione Description	Info	€	□	□
45P01BP	Bianco Blanc (RAL 1013) Blanc white (RAL 1013)		3,21	1	25
45P01GN	Grigio Noir Noir grey		3,21	1	25
45P01R	Grigio RAL 7035 7035 RAL grey		3,21	1	25

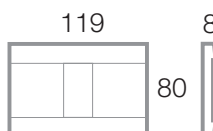

Armatura da utilizzare  
To be used with



45B63

2 Moduli 2 Modules



Cod. Code	Descrizione Description	Info	€	□	□
45P02GN	Grigio Noir Noir grey		3,14	1	25
45P02R	Grigio RAL 7035 7035 RAL grey		3,14	1	25

**Nota:** con l'armatura 45B63 sono installabili centralmente solo i prodotti del Sistema 45 contrassegnati, nella colonna "Info", con i simboli • e ②

**Note:** with the 45B63 frame, only system 45 products with the symbols • and ② in the "info" column can be installed centrally

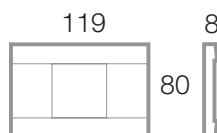

Armature da utilizzare  
To be used with



45762



45B63

2 (1+1) Moduli 2 (1+1) Modules



Cod. Code	Descrizione Description	Info	€	□	□
45P002BP	Bianco Blanc (RAL 1013) Blanc white (RAL 1013)		3,14	1	25
45P002GN	Grigio Noir Noir grey		3,14	1	25
45P002R	Grigio RAL 7035 7035 RAL grey		3,14	1	25

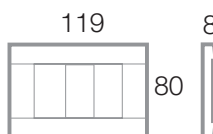

Armatura da utilizzare  
To be used with



45B63

Le dimensioni, salvo diversamente specificato, sono in mm  
Dimensions, except where otherwise specified, are in mm

◇ Prodotto per scatola quadrata  
Product for British Standard  
square box only

② Prodotto 1 modulo installabile in scatola tonda  
con altro prodotto 1 modulo  
1 module product installable in round box with  
another 1 module device

□ Imballo Minimo pcs  
Min. Packaging pcs

□ Imballo Standard pcs  
Std. Packaging pcs



**3 Moduli 3 Modules**

Design:  
H. M. R.

314



45P03R

Cod. Code	Descrizione Description	Info	€	□	□
45P03BP	Bianco Blanc (RAL 1013) <i>Blanc white (RAL 1013)</i>		3,36	1	25
45P03GN	Grigio Noir <i>Noir grey</i>		3,36	1	25
45P03R	Grigio RAL 7035 <i>7035 RAL grey</i>		3,36	1	25



45P03GN



45P03BP

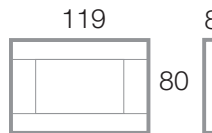

**Armatura da utilizzare**  
*To be used with*



45B63

**4 Moduli 4 Modules**



Cod. Code	Descrizione Description	Info	€	□	□
45P04BP	Bianco Blanc (RAL 1013) <i>Blanc white (RAL 1013)</i>		6,47	1	20
45P04GN	Grigio Noir <i>Noir grey</i>		6,42	1	20
45P04R	Grigio RAL 7035 <i>7035 RAL grey</i>		6,42	1	20

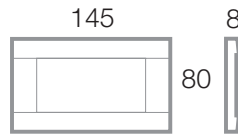

**Armatura da utilizzare**  
*To be used with*



45764

**6 Moduli 6 Modules**



Cod. Code	Descrizione Description	Info	€	□	□
45P06BP	Bianco Blanc (RAL 1013) <i>Blanc white (RAL 1013)</i>		10,72	1	15
45P06GN	Grigio Noir <i>Noir grey</i>		10,72	1	15
45P06R	Grigio RAL 7035 <i>7035 RAL grey</i>		10,72	1	15

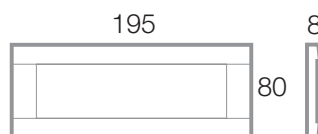

**Armatura da utilizzare**  
*To be used with*



45366



Per la disponibilità contattare la rete commerciale  
For availability please contact sales dept.



Disponibilità fino ad esaurimento scorte  
Available until stock out



Prodotto 2 moduli adatto anche per scatola tonda  
2 modules product suitable for round box



Prodotto per scatola rettangolare inglese  
Product for British standard rectangular box



Prodotto per Export  
For Export only

## Placche in tecnopolimero "Ral 45" lucide "Ral 45" glossy finish moulded front plates

Design:  
M. Hasuike

315

1 MODULO / 1 MODULE



Cod. Code	Descrizione Description	Info	€	□	□
45P01BG	Bianco Banquise (RAL 9016) <i>Banquise white (RAL 9016)</i>		3,21	1	25
45P01BL	Bianco Blanc (RAL 1013) <i>Blanc white (RAL 1013)</i>		3,21	1	25
45P01NL	Nero lucido <i>Polished black</i>		3,21	1	25

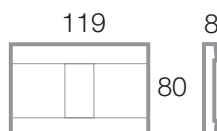

Armatura da utilizzare  
To be used with



45B63

2 Moduli 2 Modules



Cod. Code	Descrizione Description	Info	€	□	□
45P02BG	Bianco Banquise (RAL 9016) <i>Banquise white (RAL 9016)</i>		3,14	1	25
45P02BL	Bianco Blanc (RAL 1013) <i>Blanc white (RAL 1013)</i>		3,14	1	25

**Nota:** con l'armatura 45B63 sono installabili centralmente solo i prodotti del Sistema 45 contrassegnati, nella colonna "Info", con i simboli • e ②

**Note:** with the 45B63 frame, only system 45 products with the symbols • and ② in the "info" column can be installed centrally

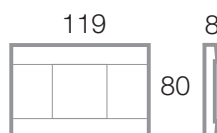

Armature da utilizzare  
To be used with



45762



45B63

2 (1+1) Moduli 2 (1+1) Modules



Cod. Code	Descrizione Description	Info	€	□	□
45P002BG	Bianco Banquise (RAL 9016) <i>Banquise white (RAL 9016)</i>		3,14	1	25
45P002BL	Bianco Blanc (RAL 1013) <i>Blanc white (RAL 1013)</i>		3,14	1	25
45P002NL	Nero lucido <i>Polished black</i>		3,14	1	25

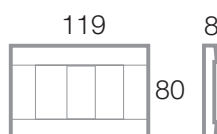

Armatura da utilizzare  
To be used with



45B63

Le dimensioni, salvo diversamente specificato, sono in mm  
Dimensions, except where otherwise specified, are in mm

◆ Prodotto per scatola quadrata  
Product for British Standard  
square box only

② Prodotto 1 modulo installabile in scatola tonda  
con altro prodotto 1 modulo  
1 module product installable in round box with  
another 1 module device

□ Imballo Minimo pcs  
Min. Packaging pcs

□ Imballo Standard pcs  
Std. Packaging pcs



# Placche

## Front Plates

# Sistema 45

3 Moduli 3 Modules

Design:  
M. Hasuike

316



45P03BG

Cod. Code	Descrizione Description	Info	€	□	□
45P03BG	Bianco Banquise (RAL 9016) Banquise white (RAL 9016)	3,36	1	25	
45P03BL	Bianco Blanc (RAL 1013) Blanc white (RAL 1013)	3,36	1	25	
45P03NL	Nero lucido Polished black	3,36	1	25	



45P03NL



45P03BL

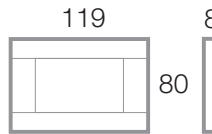

Armatura da utilizzare  
To be used with



45B63

4 Moduli 4 Modules

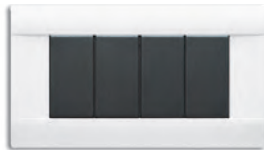

Cod. Code	Descrizione Description	Info	€	□	□
45P04BG	Bianco Banquise (RAL 9016) Banquise white (RAL 9016)	6,42	1	20	

Armatura da utilizzare  
To be used with

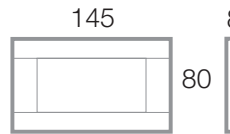

45764

6 Moduli 6 Modules

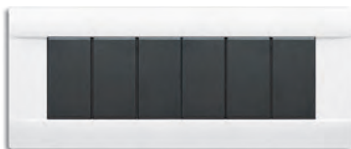

Cod. Code	Descrizione Description	Info	€	□	□
45P06BG	Bianco Banquise (RAL 9016) Banquise white (RAL 9016)	10,72	1	15	
45P06NL	Nero lucido Polished black	10,72	1	15	

Armatura da utilizzare  
To be used with

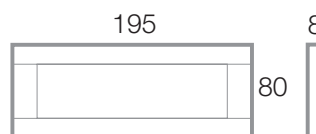

45366



Per la disponibilità contattare la rete commerciale  
For availability please contact sales dept.



Disponibilità fino ad esaurimento scorte  
Available until stock out



Prodotto 2 moduli adatto anche per scatola tonda  
2 modules product suitable for round box



Prodotto per scatola rettangolare inglese  
Product for British standard rectangular box



Prodotto per Export  
For Export only



## Placche in tecnopolimero "Yes 45" per scatola rettangolare

"Yes 45" series moulded front plates - rectangular box

Design:  
H. M. R.

1 MODULO / 1 MODULE



Cod. Code	Descrizione Description	Info	€	□	□
45PY01BB	Bianco Banquise (RAL 9016) Banquise white (RAL 9016)		2,96	1	25
45PY01BP	Bianco Blanc (RAL 1013) Blanc white (RAL 1013)		2,96	1	25
45PY01GN	Grigio Noir Noir grey		2,96	1	25

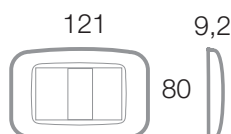

Armatura da utilizzare  
To be used with



45B63



Sistema 45

2 (1+1) Moduli 2 (1+1) Modules



Cod. Code	Descrizione Description	Info	€	□	□
45PY002BB	Bianco Banquise (RAL 9016) Banquise white (RAL 9016)		2,96	1	25
45PY002BP	Bianco Blanc (RAL 1013) Blanc white (RAL 1013)		2,96	1	25
45PY002GN	Grigio Noir Noir grey		2,96	1	25

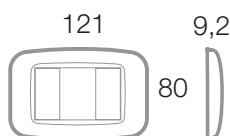

Armatura da utilizzare  
To be used with



45B63

2 Moduli 2 Modules



Cod. Code	Descrizione Description	Info	€	□	□
45PY02BB	Bianco Banquise (RAL 9016) Banquise white (RAL 9016)		2,96	1	25
45PY02BP	Bianco Blanc (RAL 1013) Blanc white (RAL 1013)		2,96	1	25
45PY02GN	Grigio Noir Noir grey		2,96	1	25

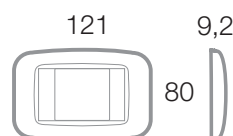

Armatura da utilizzare  
To be used with



45762



45B63

Le dimensioni, salvo diversamente specificato, sono in mm  
Dimensions, except where otherwise specified, are in mm

◆ Prodotto per scatola quadrata  
Product for British Standard  
square box only

② Prodotto 1 modulo installabile in scatola tonda  
con altro prodotto 1 modulo  
1 module product installable in round box with  
another 1 module device

□ Imballo Minimo pcs  
Min. Packaging pcs

□ Imballo Standard pcs  
Std. Packaging pcs





3 Moduli 3 Modules

Design:  
H. M. R.

318

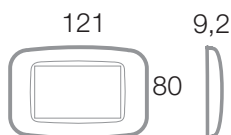

Armatura da utilizzare  
To be used with



45B63

Cod. Code	Descrizione Description	Info	€	□	□
45PY03AO	Argento opaco Matt silver		10,21	1	25
45PY03BB	Bianco Banquise (RAL 9016) Banquise white (RAL 9016)		2,88	1	25
45PY03BP	Bianco Blanc (RAL 1013) Blanc white (RAL 1013)		2,96	1	25
45PY03CHO	Champagne opaco Champagne		10,21	1	25
45PY03GN	Grigio Noir Noir grey		2,96	1	25
45PY03GSM	Grigio scuro metallizzato Metallic dark grey		10,21	1	25
45PY03OT	Ottone lucido Polished brass		18,77	1	25

**Placche in tecnopolimero "Yes 45" per scatola rettangolare**  
"Yes 45" series moulded front plates - rectangular box

Design:  
H. M. R.

4 MODULI / 4 MODULES

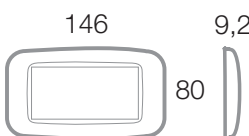

Armatura da utilizzare  
To be used with



45764

Cod. Code	Descrizione Description	Info	€	□	□
45PY04AO	Argento opaco Matt silver		14,45	1	20
45PY04BB	Bianco Banquise (RAL 9016) Banquise white (RAL 9016)		5,96	1	20
45PY04BP	Bianco Blanc (RAL 1013) Blanc white (RAL 1013)		6,09	1	20
45PY04CHO	Champagne opaco Champagne		14,45	1	20
45PY04GN	Grigio Noir Noir grey		6,09	1	20
45PY04GSM	Grigio scuro metallizzato Metallic dark grey		14,45	1	20
45PY04OT	Ottone lucido Polished brass		23,65	1	20

6 Moduli 6 Modules

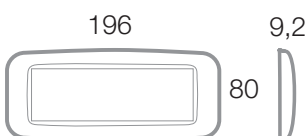

Cod. Code	Descrizione Description	Info	€	□	□
45PY06AO	Argento opaco Matt silver		16,83	1	15
45PY06BB	Bianco Banquise (RAL 9016) Banquise white (RAL 9016)		9,65	1	15
45PY06BP	Bianco Blanc (RAL 1013) Blanc white (RAL 1013)		9,65	1	15
45PY06CHO	Champagne opaco Champagne		16,83	1	15
45PY06GN	Grigio Noir Noir grey		9,65	1	15
45PY06GSM	Grigio scuro metallizzato Metallic dark grey		16,35	1	15
45PY06OT	Ottone lucido Polished brass		27,87	1	15



Per la disponibilità contattare  
la rete commerciale  
For availability please contact  
sales dept.



Disponibilità fino ad  
esaurimento scorte  
Available until stock out



Prodotto 2 moduli adatto  
anche per scatola tonda  
2 modules product suitable  
for round box



Prodotto per scatola  
rettangolare inglese  
Product for British standard  
rectangular box



Prodotto per Export  
For Export  
only

**1 Modulo 1 Module**

Cod. Code	Descrizione Description	Cornicetta Adapter frame	Info	€	□	□
45P21BB	Bianco Banquise (RAL 9016) Banquise white (RAL 9016)	Bianco Banquise (RAL 9016) Banquise white (RAL 9016)	3,30 1 30			
45P21BP	Bianco blanc (RAL 1013) Blanc white (RAL 1013)	Bianco Blanc (RAL 1013) Blanc white (RAL 1013)	3,30 1 30			

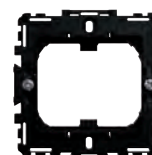
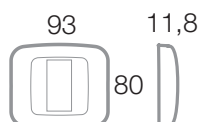
 Armatura da utilizzare  
To be used with

45362EX

319



Sistema 45

**2 Moduli 2 Modules**

45P22BB

Cod. Code	Descrizione Description	Cornicetta Adapter frame	Info	€	□	□
45P22BB	Bianco Banquise (RAL 9016) Banquise white (RAL 9016)	Bianco Banquise (RAL 9016) Banquise white (RAL 9016)	3,30 1 30			
45P22BP	Bianco blanc (RAL 1013) Blanc white (RAL 1013)	Bianco Blanc (RAL 1013) Blanc white (RAL 1013)	3,30 1 30			

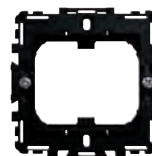
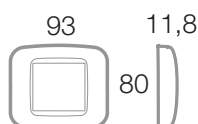
 Armatura da utilizzare  
To be used with

45362EX

**4 (2+2) Moduli 4 (2+2) Modules**

Cod. Code	Descrizione Description	Cornicetta Adapter frame	Info	€	□	□
45P24BB	Bianco Banquise (RAL 9016) Banquise white (RAL 9016)	Bianco Banquise (RAL 9016) Banquise white (RAL 9016)	5,39 1 15			
45P24BP	Bianco blanc (RAL 1013) Blanc white (RAL 1013)	Bianco Blanc (RAL 1013) Blanc white (RAL 1013)	5,39 1 15			

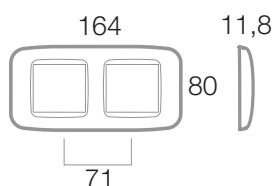
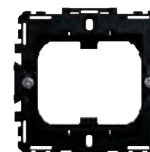
 Installazione orizzontale o  
verticale  
Horizontal and vertical  
installation

 Armatura da utilizzare  
To be used with

n° 2 45362EX

 Le dimensioni, salvo diversamente specificato, sono in mm  
Dimensions, except where otherwise specified, are in mm

 Prodotto per scatola quadrata  
Product for British Standard  
square box only

 Prodotto 1 modulo installabile in scatola tonda  
con altro prodotto 1 modulo  
1 module product installable in round box with  
another 1 module device

 Imballo Minimo pcs  
Min. Packaging pcs

 Imballo Standard pcs  
Std. Packaging pcs



# Placche

## Front Plates

# Sistema 45

### Placche in tecnopolimero "Yes 45" per scatola tonda o quadrata

"Yes 45" series moulded front plates - square or round box

Design:  
H. M. R.

320

6(2+2+2) MODULI / 6(2+2+2) MODULES

Cod. Code	Descrizione Description	Cornicetta Adapter frame	Info	€	□	□
45P26BB	Bianco Banquise (RAL 9016) Banquise white (RAL 9016)	Bianco Banquise (RAL 9016) Banquise white (RAL 9016)		9,04	1	30



Installazione orizzontale o  
verticale  
Horizontal and vertical  
installation

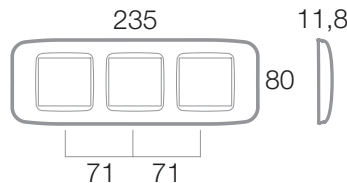

Armatura da utilizzare  
To be used with

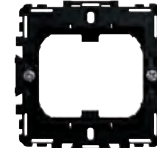

n° 3 45362EX

### Accessori placche in tecnopolimero "Yes 45" per scatola tonda o quadrata

"Yes 45" series moulded front plates accessories - square or round box

1 MODULO / 1 MODULE

Cod. Code	Descrizione Description	Info	€	□	□
45CR1BB	Cornice di ricambio 1 mod. color Banquise (RAL 9016) Banquise white (RAL 9016) 1 module spare adapter frame		1,41	5	100
45CR1BP	Cornice di ricambio 1 mod. color Blanc (RAL 1013) Blanc (RAL 1013) white 1 module spare adapter frame		1,41	5	100



### Accessori placche in tecnopolimero "Yes 45" per scatola tonda o quadrata

"Yes 45" series moulded front plates accessories - square or round box

2 MODULI / 2 MODULES

Cod. Code	Descrizione Description	Info	€	□	□
45CR2BB	Cornice di ricambio 2 mod. color Banquise (RAL 9016) Banquise (RAL 9016)white 2 modules spare adapter frame		1,41	5	100
45CR2BP	Cornice di ricambio 2 mod. color Blanc (RAL 1013) Blanc (RAL 1013) white 2 modules spare adapter frame		1,41	5	100



### Sequenza di assemblaggio Installation

Scatola da  
incasso 2502  
2502 flush  
mounted box

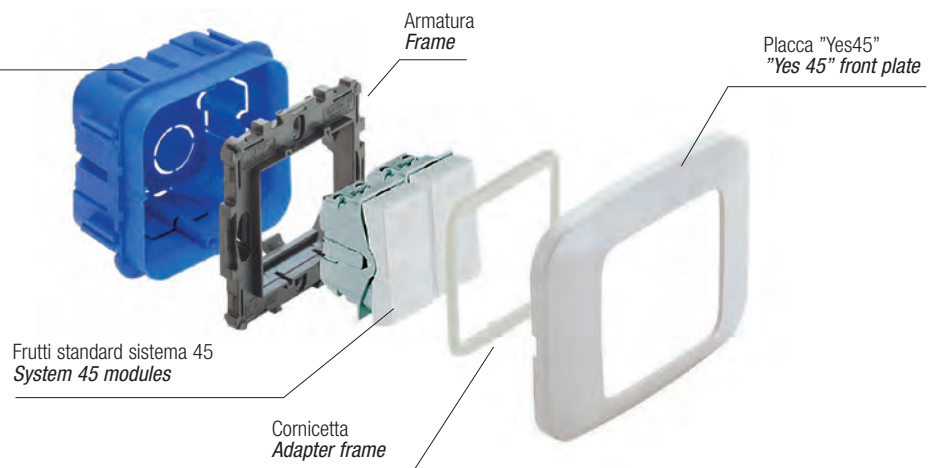

Frutti standard sistema 45  
System 45 modules

Cornicetta  
Adapter frame

Placca "Yes45"  
"Yes 45" front plate



Per la disponibilità contattare  
la rete commerciale  
For availability please contact  
sales dept.



Disponibilità fino ad  
esaurimento scorte  
Available until stock out



Prodotto 2 moduli adatto  
anche per scatola tonda  
2 modules product suitable  
for round box



Prodotto per scatola  
rettangolare inglese  
Product for British standard  
rectangular box



Prodotto  
per Export  
For Export  
only

## Placche autoportanti in tecnopolimero "Yesmin" "Yesmin" series self-supporting moulded front plates

Design:  
H. M. R.

321

1 MODULO / 1 MODULE



45PA1BB

Cod. Code Descrizione Description

45PA1BB Bianco Banquise (RAL 9016)  
Banquise white (RAL 9016)

Info

€ □ □

3,98 10 10

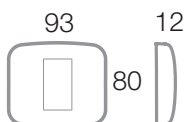

2 Moduli 2 Modules



Cod. Code Descrizione Description

45PA2BB Bianco Banquise (RAL 9016)- con griffe  
Banquise white (RAL 9016) - with clips

Info

€ □ □

3,98 10 10

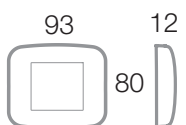

## Placche in tecnopolimero "Mini 45" per pannelli/profilati "Mini 45" moulded front plates for section bars

1 MODULO / 1 MODULE



45PF1BB



45PF1A0

Cod. Code Descrizione Description

45PF1A0 Argento Opaco  
Matt silver

Info

€ □ □

7,41 1 50

45PF1BB Bianco Banquise (RAL 9016)  
Banquise white (RAL 9016)

4,00 1 50

Armatura da utilizzare  
To be used with

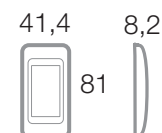

45B61

Esempio installativo Installation example

Installazione in interni di imbarcazioni  
Indoor installation of boats

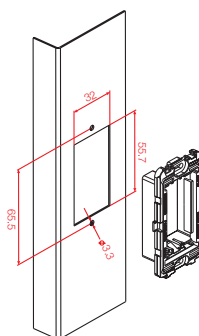

Le dimensioni, salvo diversamente specificato, sono in mm  
Dimensions, except where otherwise specified, are in mm

◇ Prodotto per scatola quadrata  
Product for British Standard  
square box only

② Prodotto 1 modulo installabile in scatola tonda  
con altro prodotto 1 modulo  
1 module product installable in round box with  
another 1 module device

□ Imballo Minimo pcs  
Min. Packaging pcs

□ Imballo Standard pcs  
Std. Packaging pcs



# Placche

## Front Plates

# Sistema 45

Placche in tecnopolimero multimodulo "Maxi Yes" per scatola BL02P  
Multi-module "Maxi Yes" series moulded front plates - for BL02P box

Design:  
H. M. R.

322

20 (5+5+ 5+5) Moduli Modules

Cod. Code Descrizione Description

Info

€ □ □

45PY020BB Bianco Banquise (RAL 9016)  
Banquise white (RAL 9016)

47,73 1 16

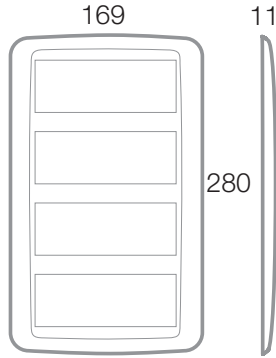

Armatura da utilizzare  
To be used with



45760/20

Scatola da utilizzare  
To be used with



BL07P

Pareti in muratura  
Brickwork walls

BL07CG  
BL07CGN

Pareti in cartongesso  
Hollow walls



Per la disponibilità contattare  
la rete commerciale  
For availability please contact  
sales dept.



Disponibilità fino ad  
esaurimento scorte  
Available until stock out



Prodotto 2 moduli adatto  
anche per scatola tonda  
2 modules product suitable  
for round box



Prodotto per scatola  
rettangolare inglese  
Product for British standard  
rectangular box



Prodotto  
per Export  
For Export  
only

45760/20

## Placche in tecnopolimero "Blanc 45" "BLANC 45" moulded front plates

Design:  
A. Van Onck

323

3 MODULI / 3 MODULES



45P63

Cod. Code Descrizione Description

45P63 Bianco Blanc (RAL 1013)  
Blanc white (RAL 1013)

Info

€ □ □  
5,97 1 25

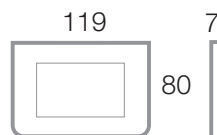

Armatura da utilizzare  
To be used with



45B63

1 Modulo 1 Module



45P61

Cod. Code Descrizione Description

45P61 Bianco Blanc (RAL 1013)  
Blanc white (RAL 1013)

Info

€ □ □  
5,97 1 25

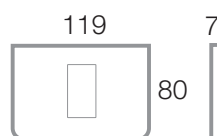

Armatura da utilizzare  
To be used with



45B63

1+1 Moduli 1+1 Modules

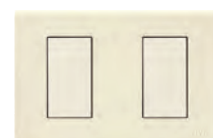

Cod. Code Descrizione Description

45P62 Bianco Blanc (RAL 1013)  
Blanc white (RAL 1013)

Info

€ □ □  
5,97 1 25

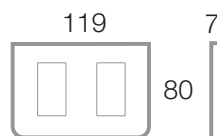

Armatura da utilizzare  
To be used with



45B63

4 Moduli 4 Modules



Cod. Code Descrizione Description

45P64 Bianco Blanc (RAL 1013)  
Blanc white (RAL 1013)

Info

€ □ □  
8,23 1 20

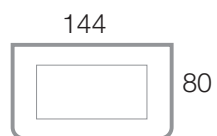

Armatura da utilizzare  
To be used with



45764

Le dimensioni, salvo diversamente specificato, sono in mm  
Dimensions, except where otherwise specified, are in mm

◇ Prodotto per scatola quadrata  
Product for British Standard  
square box only

② Prodotto 1 modulo installabile in scatola tonda  
con altro prodotto 1 modulo  
1 module product installable in round box with  
another 1 module device

□ Imballo Minimo pcs  
Min. Packaging pcs

□ Imballo Standard pcs  
Std. Packaging pcs



# Supporti e contenitori **Sistema 45**

**System 45**  
Frames and enclosures

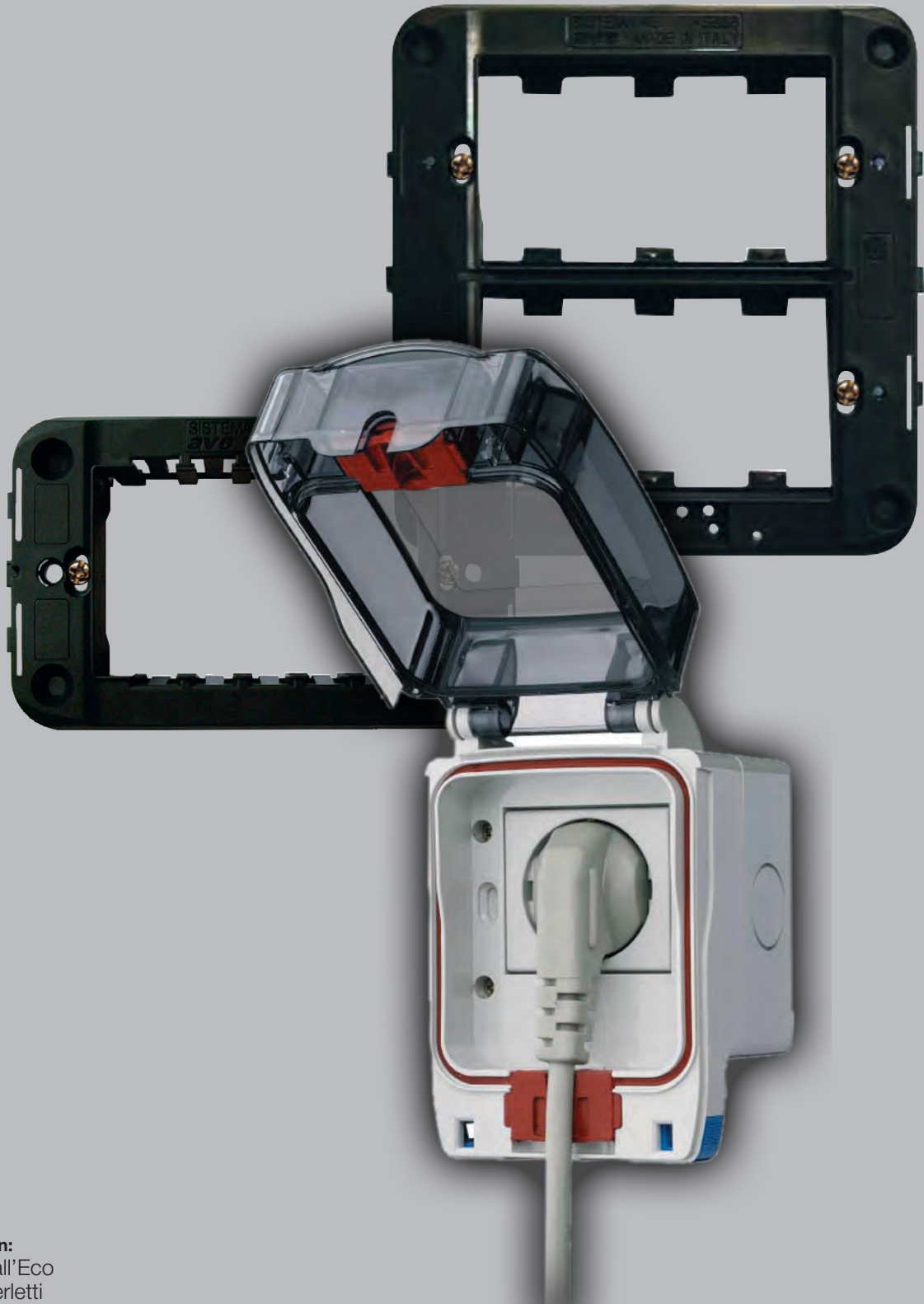

**Design:**  
B. Dall'Eco  
L. Merletti

**Indice**  
**Index**

Supporti  
Frames

**326**

Contenitori  
Enclosures

**328**



Armature per pannelli/profilati  
Frames for section bars

326

Cod. Code	Descrizione Description	Info	€	□	□
45B61	Armatura 1 modulo per pannelli/profilati accoppiabile in verticale - con viti <i>1 module frame with fixing screws for section bars installations</i>		2,20	10	10



45B61

Armature per scatole tonde e quadrate *Frames for round and square boxes*

Cod. Code	Descrizione Description	Info	€	□	□
45361	Armatura 1 modulo per scatola tonda 60mm per placche 45PY01..., 45P01..., 45P31, 45P61 <i>1 module frame for 60mm round box for plates 45PY01..., 45P01..., 45P31, 45P61</i>		2,61	50	50
45762	Armatura 2 moduli affiancati per placche 45P02... - 45P92... - 45PB02... - 45PY02...45P622 - 45P722 - installabile su scatola quadrata con interasse 60mm (cod. AVE 2502) o standard rettangolare (cod. AVE 2503MG) 3 moduli <i>2 modules frame to be used with front plates 45P02... - 45P92... 45P622 - 45P722 - it can be installed on square boxes with centre distance 60 mm (code AVE 2502) or 3 modules rectangular standard (AVE code 2503MG)</i>		2,56	50	50
45362EX	Armatura 1-2 moduli per scatola quadrata o tonda 60mm - accoppiabile in orizzontale o verticale - con griffe laterali <i>1-2 modules frame with side clips for squared or 60mm round boxes - it can be coupled either vertically or horizontally</i>		2,33	70	70
45363	Armatura 1-2 moduli per scatola tonda 60mm o quadrata - con griffe - da utilizzare con placche 45P11...e 45P12... <i>1-2 modules frame for 60mm round box - with clips to be used with front plates codes 45P11...and 45P12...</i>		2,47	50	50

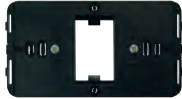

45361



45762



45362EX



45363

Armature per scatole rettangolari *Frames for rectangular boxes*

Cod. Code	Descrizione Description	Info	€	□	□
45B63	Armatura 1-3 moduli per scatole 2503MG <i>1-3 modules frame for 2503MG boxes</i>		1,44	120	120
45366	Armatura 6 moduli per scatole 2506 <i>6 modules frame for 2506 boxes</i>		5,37	8	8
45762	Armatura 2 moduli affiancati per placche 45P02... - 45P92... - 45PB02... - 45PY02...45P622 - 45P722 - installabile su scatola quadrata con interasse 60mm (cod. AVE 2502) o standard rettangolare (cod. AVE 2503MG) - 3 moduli <i>2 modules frame to be used with front plates 45P02...-45P92... - 45PB02...45PY02...45P622 - 45P722 - it can be installed on square boxes with centre distance 60 mm (code AVE 2502) or 3 modules rectangular standard (AVE code 2503MG)</i>		2,56	50	50
45764	Armatura 4 moduli per scatole 2504 <i>4 modules frame for 2504 boxes</i>		3,61	15	15
45B66	Armatura 6 moduli (3+3) per scatole BL02P, 45SY6 <i>6 modules frame (3+3) for BL02P, 45SY6 boxes</i>		4,45	8	8



45B63



45764



45366



45B66



Per la disponibilità contattare la rete commerciale  
For availability please contact sales dept.



Disponibilità fino ad esaurimento scorte  
Available until stock out



Prodotto 2 moduli adatto anche per scatola tonda  
2 modules product suitable for round box



Prodotto per scatola rettangolare inglese  
Product for British standard rectangular box



Prodotto per Export  
For Export only

## Armature speciali Special frames

Cod. Code	Descrizione Description	Info	€	□	□
45360	<p>Armatura 1-3 moduli per l'installazione di tutti i prodotti che per ragioni di dimensioni <b>non possono</b> essere installati nelle armature standard sistema 45 Ave quali:</p> <ul style="list-style-type: none"> <li>- prese rasoio cod. 45...33RS</li> <li>- microautomatici 3KA cod. 45...52NX6, 45...52NX10, 45...52NX16</li> <li>- magnetotermici differenziali cod. 45...62NX6, 45...62NX10, 45...62NX16</li> </ul> <p>1-3 modules special frame for the devices that do not fit a standard S45 frame. The products that require this special frame are:</p> <ul style="list-style-type: none"> <li>- Shaver socket (45...33RS)</li> <li>- 3kA Micro MCBs (45...52NX6, 45...52NX10, 45...52NX16)</li> <li>- Micro combined MCB/RCDs (45...62NX6, 45...62NX10, 45...62NX16)</li> </ul>	2,98	1	12	
45364	Come sopra ma per 1-4 moduli As above, for 1-4 modules	4,42	1	12	



45360



45364

**Nota:** permettono inoltre, tramite gli appositi adattatori forniti in dotazione, di alloggiare tutti i frutti standard del sistema 45 Ave (vedi figura sotto riportata)  
**Note:** All standard S45 modules can be fitted to these frames by using the dedicated adaptors (see picture below)

**Esempio di installazione su Armatura 45360:**  
 microinterruttore + presa schuko bipasso del Sistema 45 AVE  
**Installation example 45369 Special Use Frame, micro MCB + System 45 schuko socket**

I prodotti del Sistema 45 con aggancio standard si montano sulle armature 45360 - 45364 con l'utilizzo degli adattatori in dotazione con l'armatura.

System 45 products with standard clippings are fitted to Ref. 45360 and 45364 with the adaptors provided with the frames.

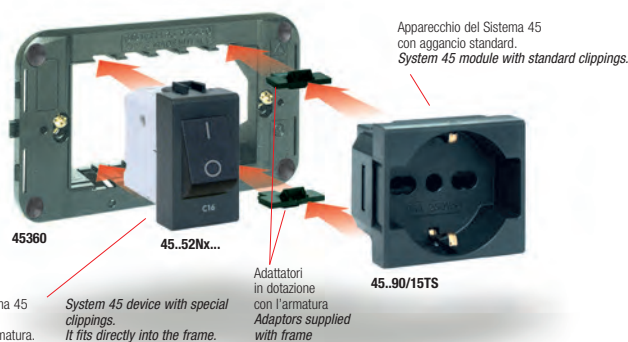

## Armature per moduli multipli Multi-module frames

Cod. Code	Descrizione Description	Info	€	□	□
45760/10	<p>Armatura 10 moduli per scatole 53SA05, 53SA05BG, BL05P, BL05CG, 45SY10, 45SY10AO</p> <p>10 modules frame for 53SA05, 53SA05BG, BL05P, 45SY10, 45SY10AO boxes</p>	8,71	1	1	
45760/15	<p>Armatura 15 moduli per scatole BL06P</p> <p>15 modules frame for BL06P boxes</p>	9,61	1	1	
45760/20	<p>Armatura 20 moduli per scatole BL07P, 53SA12BG, , 45SY20AO</p> <p>20 modules frame for BL07P, 53SA12BG, , 45SY20AO boxes</p>	10,79	1	1	



45760/10

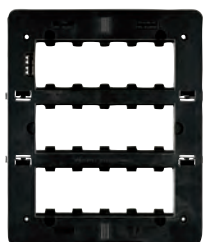

45760/15



45760/20

**Rimozione setto separatore**  
 Divider removal



Le dimensioni, salvo diversamente specificato, sono in mm  
 Dimensions, except where otherwise specified, are in mm

◇ Prodotto per scatola quadrata  
 Product for British Standard square box only

② Prodotto 1 modulo installabile in scatola tonda con altro prodotto 1 modulo  
 1 module product installable in round box with another 1 module device

□ Imballo Minimo pcs  
 Min. Packaging pcs

□ Imballo Standard pcs  
 Std. Packaging pcs





# Contenitori

Enclosures

Sistema 45

Contenitori industriali autoportanti IP40 da parete RAL7035 per tubo  
IP40 indust. wall mounted enclosures for duct - self-supporting - RAL7035

328

Dimensioni d'ingombro (in mm) Dimensions (mm)

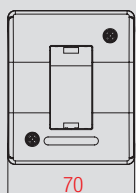

45Q41

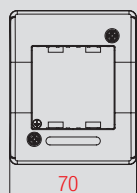
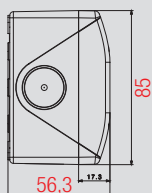

45Q42

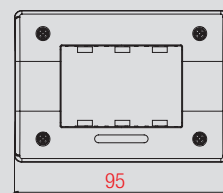
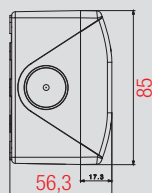

45Q43

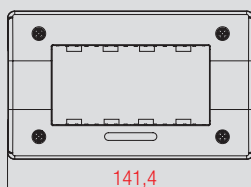
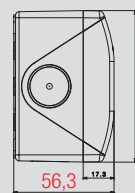

45Q44

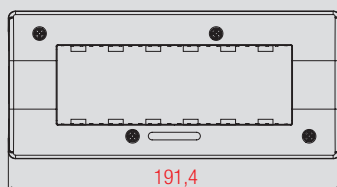
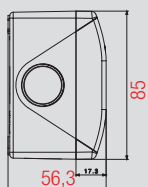

45Q46

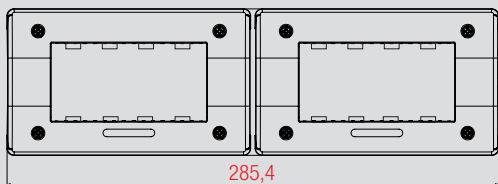
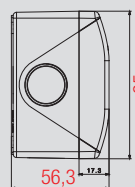

45Q480R

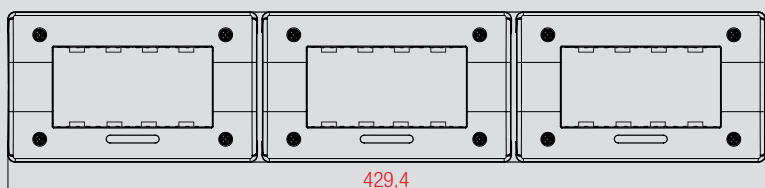
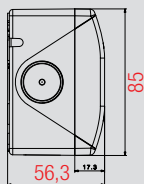

45Q4120R

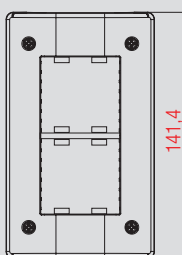
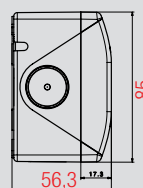

45Q44V

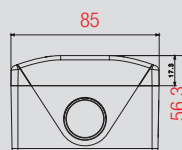

Caratteristiche Tecniche Technical Features



Per la disponibilità contattare la rete commerciale  
For availability please contact sales dept.



Disponibilità fino ad esaurimento scorte  
Available until stock out



Prodotto 2 moduli adatto anche per scatola tonda  
2 modules product suitable for round box



Prodotto per scatola rettangolare inglese  
Product for British standard rectangular box



Prodotto per Export  
For Export only

**Contenitori industriali autoportanti IP40 da parete RAL7035 per tubo**  
*IP40 indust. wall mounted enclosures for duct - self-supporting - RAL7035*

Cod. Code	Descrizione Description	Info	€	□	□
45Q41	1 modulo <i>1 module</i>		2,59	24	24
45Q42	2 moduli <i>2 modules</i>		2,59	24	24
45Q43	3 moduli <i>3 modules</i>		3,70	20	20
45Q44	4 moduli <i>4 modules</i>		4,88	20	20
45Q44V	4 (2+2) moduli - installazione verticale <i>4 (2+2) modules - vertical installation</i>		4,88	20	20
45Q46	6 moduli <i>6 modules</i>		7,35	1	10
45Q480R	8 (4+4) moduli - installazione orizzontale <i>8 (4+4) modules - horizontal installation</i>		8,36	1	6
45Q4120R	12 (4+4+4) moduli - installazione orizzontale <i>12 (4+4+4) modules - horizontal installation</i>		12,07	1	18
45ST99	Scatola di derivazione da parete <i>Wall mounted junction box</i>		5,60	1	20



45Q41 45Q42



45Q43



45Q44

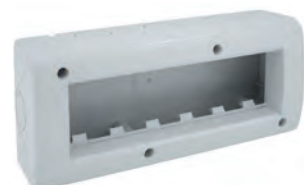

45Q46

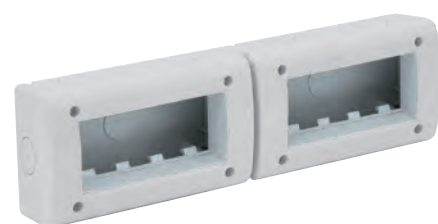

45Q480R



45Q44V



45ST99



45Q4120R

Le dimensioni, salvo diversamente specificato, sono in mm  
 Dimensions, except where otherwise specified, are in mm

◇ Prodotto per scatola quadrata  
 Product for British Standard  
 square box only

② Prodotto 1 modulo installabile in scatola tonda  
 con altro prodotto 1 modulo  
 1 module product installable in round box with  
 another 1 module device

□ Imballo Minimo pcs  
 Min. Packaging pcs

□ Imballo Standard pcs  
 Std. Packaging pcs







# Contenitori

Enclosures

Sistema 45

Contenitori autoportanti IP40 da parete RAL1013  
IP40 wall mounted enclosures - self-supporting - RAL1013

330

Dimensioni d'ingombro (in mm) *Dimensions (mm)*

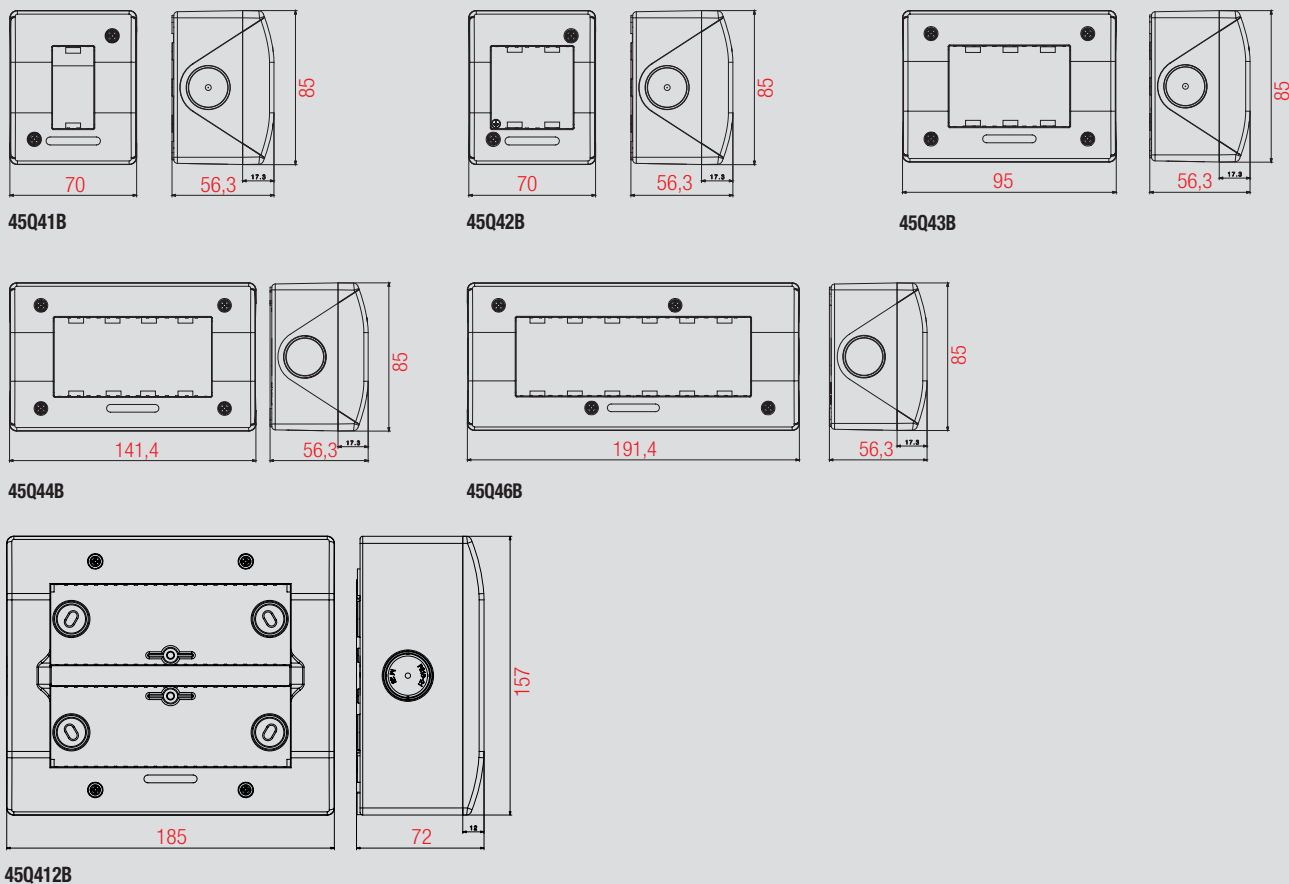
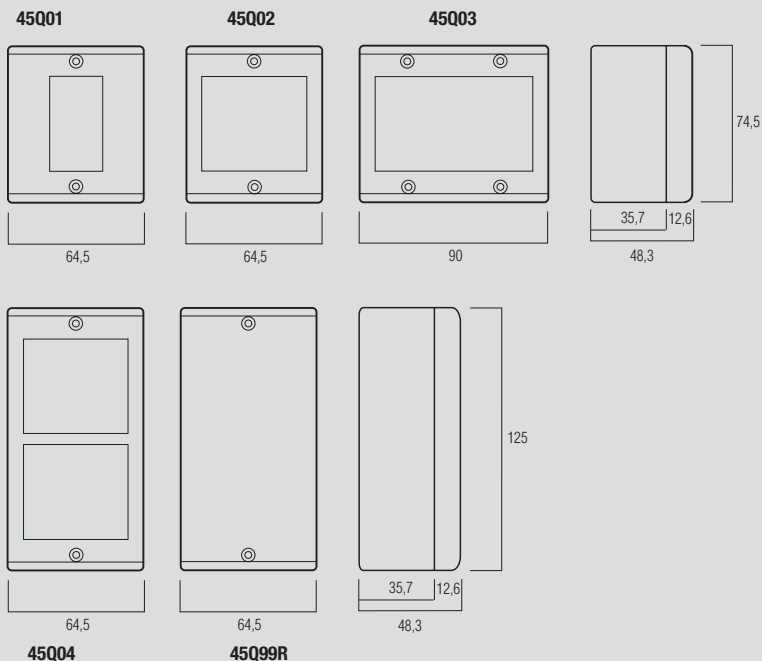

Caratteristiche Tecniche *Technical Features*



Per la disponibilità contattare la rete commerciale  
For availability please contact sales dept.



Disponibilità fino ad esaurimento scorte  
Available until stock out



Prodotto 2 moduli adatto anche per scatola tonda  
2 modules product suitable for round box



Prodotto per scatola rettangolare inglese  
Product for British standard rectangular box



Prodotto per Export  
For Export only

## Contenitori autoportanti IP40 da parete RAL1013

IP40 wall mounted enclosures - self-supporting - RAL1013

	Cod. Code	Descrizione Description	Info	€	□	□
	45Q01	1 modulo 1 module		3,70	30	30
	45Q02	2 moduli 2 modules		3,70	30	30
	45Q03	3 moduli 3 modules		5,04	24	24
	45Q04	4 (2+2) moduli - installazione verticale 4 (2+2) modules - vertical installation		6,29	20	20
	45Q99R	Scatola di derivazione a parete - colore RAL7035 Wall mounted junction box - RAL7035 colour		7,01	20	20

45Q01



45Q02



45Q03



45Q04

331



Sistema 45

## Contenitori industriali autoportanti IP40 da parete RAL 9016 per tubo

IP40 indust. wall mounted enclosures for duct- self-supporting - RAL 9016

	Cod. Code	Descrizione Description	Info	€	□	□
	45Q41B	1 modulo 1 module		2,59	24	24
	45Q42B	2 moduli 2 modules		2,59	24	24
	45Q43B	3 moduli 3 modules		3,70	20	20
	45Q44B	4 moduli 4 modules		4,88	20	20
	45Q46B	6 moduli 6 modules		7,35	1	10
	45Q412B	12 (6+6) moduli 12 (6+6) modules		12,02	1	6

45Q41B



45Q42B



45Q43B



45Q44B



45Q46B



45Q412B

Le dimensioni, salvo diversamente specificato, sono in mm  
Dimensions, except where otherwise specified, are in mm

◇ Prodotto per scatola quadrata  
Product for British Standard  
square box only

② Prodotto 1 modulo installabile in scatola tonda  
con altro prodotto 1 modulo  
1 module product installable in round box with  
another 1 module device

□ Imballo Minimo pcs  
Min. Packaging pcs

□ Imballo Standard pcs  
Std. Packaging pcs



**Contenitori autoportanti IP40 da parete RAL9016 "Yesmin" - per minicanale**  
"Yesmin" wall mounted IP40 Enclosures RAL 9016 - self-supporting - for mini trunkings

332



45QY1BB



45QY2BB

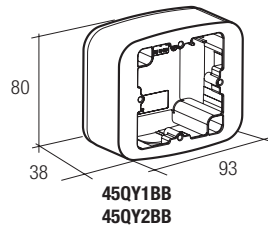

Cod. Code	Descrizione Description	Info	€	□	□
45QY1BB	1 modulo 1 module		3,86	1	30
45QY2BB	2 moduli 2 modules		3,86	1	30

**Scatole portafrutto da parete RAL 9016 per placche "YES 45" - per minicanale**  
Wall mounted boxes for "YES 45" front plates RAL 9016 - for mini trunkings



45SY02



45SY2

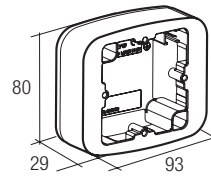

45SY02

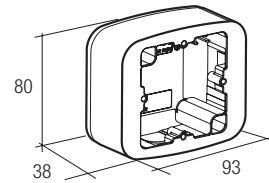

45SY2

Cod. Code	Descrizione Description	Info	€	□	□
45SY02	1-2 moduli - profondita ridotta - colore bianco Banquise 1-2 modules Banquise white reduced depth box		3,04	1	30
45SY2	1-2 moduli - colore bianco Banquise 1-2 modules Banquise white box		3,72	1	30

**Scatole portafrutto da parete per placche "MAXI YES" - per minicanale**  
Wall mounted boxes for "MAXI YES" front plates - for mini trunkings



45SY6

Cod. Code	Descrizione Description	Info	€	□	□
45SY6	6 moduli (3+3) - colore Bianco Banquise - da utilizzare con armatura 45B66 - da completare con placche codice 45PY033... 6 modules (3+3) banquise white box to be used with 45B66 frames and 45PY003... front plates		7,13	1	15

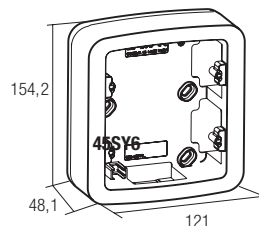

Per la disponibilità contattare la rete commerciale  
For availability please contact sales dept.



Disponibilità fino ad esaurimento scorte  
Available until stock out



Prodotto 2 moduli adatto anche per scatola tonda  
2 modules product suitable for round box





Prodotto per scatola rettangolare inglese  
Product for British standard rectangular box



Prodotto per Export  
For Export only

## Scatole Universali IP40 per minicanali RAL 9010

### IP40 RAL 9010 Universal boxes for mini trunkings

	Cod. Code	Descrizione Description	Info	€	□	□
	44SC03	3 moduli - da utilizzare con armature standard 3 moduli (interasse 83,5 mm) - per minicanali da 20x10 mm a 30x18 mm <i>3 modules - to be used with standard 3 modules frames (centre distance 83,5 mm) for trunkings from 20x10 mm to 30x18 mm</i>		7,37	1	20
44SC03						
	44SC04	4 moduli - da utilizzare con armature standard 4 moduli (interasse 108 mm) - per minicanali da 20x10 mm a 30x18 mm <i>4 modules - to be used with standard 4 modules frames (centre distance 108 mm) for trunkings from 20x10 mm to 30x18 mm</i>		9,10	1	15
44SC04						
		<b>Nota: adatte anche per placche Sistema 44</b> <b>Note: suitable also for System 44 front plates</b>				
						



333





Sistema 45

## Scatole portafrutto da parete per placche "Ral 45" e "Zama 45"

### Wall mounted boxes for "Ral 45" and "Zama 45" front plates

	Cod. Code	Descrizione Description	Info	€	□	□
	45SA03	Scatola d'arredo 3 moduli bianco Banquise (RAL 9016) - da utilizzare con armature standard 3 moduli - completare con placche codice 45P93... o 45P03... <i>3 modules white box to be used with System 45 3 modules frames to be completed with 45P93... or 45P03... front plates</i>		7,51	1	16
45SA03						
	45SA03GN	Scatola d'arredo 3 moduli grigio Noir - da utilizzare con armature standard 3 moduli. - completare con placche codice 45P93... o 45P03... <i>3 modules Noir grey box to be used with System 45 3 modules frames to be completed with 45P93... or 45P03... front plates</i>		7,51	1	16
45SA03GN						
	45CI03	Cornice rialzatrice inclinata 3 moduli bianco Banquise (RAL 9016) <i>3 modules Banquise white (RAL 9016) angled raiser frame</i>		7,02	1	1
45CI03						

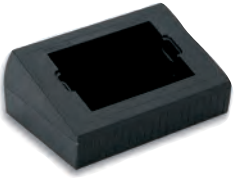
## Scatole e contenitori da tavolo Desktop box and enclosures

	Cod. Code	Descrizione Description	Info	€	□	□
	45SI03GN	Scatola inclinata 3 moduli grigio Noir - da utilizzare con armature standard 3 moduli - completare con placche codice 45P93... o 45P03... <i>3 modules Noir grey angled box to be used with System 45 3 modules frames to be completed with 45P93... or 45P03... front plates</i>		11,17	1	1
45SI03GN						
	45TL3BMC	Contenitore autoportante da tavolo 3 moduli bianco Banquise (RAL 9016) - completo di placca color bianco Banquise micalizzato <i>3 modules Banquise white (RAL 9016) desktop enclosure with mica-finished Banquise white front plate</i>		34,02	1	12
45TL3BMC						

Le dimensioni, salvo diversamente specificato, sono in mm  
Dimensions, except where otherwise specified, are in mm

◇ Prodotto per scatola quadrata  
Product for British Standard square box only

② Prodotto 1 modulo installabile in scatola tonda con altro prodotto 1 modulo  
1 module product installable in round box with another 1 module device

□ Imballo Minimo pcs  
Min. Packaging pcs

□ Imballo Standard pcs  
Std. Packaging pcs





## Contenitori

Enclosures

Scatole portafrutto da parete per placche "Zama 45" multimodulo  
Wall mounted boxes for "Zama 45" multi-module front plates

334

Esempio di utilizzo *Applications exemple*



Installazione *Installation*



Sportello rigido antiurto: non ingiallisce anche se esposto a raggi solari diretti

*Anti-shock rigid cover: it doesn't yellow even if directly exposed to sunbeams*

Apparecchi Sistema 45 AVE  
*System 45 AVE devices*

Scatola da incasso cod. 2502  
*Flush-mounted box code 2502*



Per la disponibilità contattare la rete commerciale  
For availability please contact sales dept.



Disponibilità fino ad esaurimento scorte  
Available until stock out



Prodotto 2 moduli adatto anche per scatola tonda  
2 modules product suitable for round box















Prodotto per scatola rettangolare inglese  
Product for British standard rectangular box



Prodotto per Export  
For Export only

Caratteristiche Tecniche *Technical Features*

## Placche stagne (IP55) autoportanti con sportello con membrana cedibile IP55 front plates with soft membrane cover - self-supporting

Descrizione Description		Info	€	□	□
		<b>45SP43N</b> Placca 3 moduli stagna con membrana - autoportante (non necessita di armatura portafrutti) - grigio RAL 7035 <i>IP55 splashproof 3 modules front plate with soft membrane cover - self-supporting (no frame is required) - RAL 7035 grey</i>	<b>9,43</b>	6	6
		<b>45SP43BN</b> Placca 3 moduli stagna con membrana - autoportante (non necessita di armatura portafrutti) - bianco Banquise (RAL 9016) <i>IP55 splashproof 3 modules front plate with soft membrane cover - self-supporting (no frame is required) - Banquise white (RAL 9016)</i>	<b>9,83</b>	6	6
		<b>45SP43BPN</b> Placca 3 moduli stagna con membrana - autoportante (non necessita di armatura portafrutti) - bianco Blanc (RAL 1013) <i>IP55 splashproof 3 modules front plate with soft membrane cover - self-supporting (no frame is required) - Blanc white (RAL 1013)</i>	<b>9,83</b>	6	6
		<b>45SP43GM</b> Placca 3 moduli stagna con membrana - autoportante (non necessita di armatura portafrutti) - grigio metallizzato <i>IP55 splashproof 3 modules front plate with soft membrane cover - self-supporting (no frame is required) - Metallic grey</i>	<b>10,92</b>	6	6
		<b>45SP44</b> Placca 4 moduli stagna con membrana - autoportante (non necessita di armatura portafrutti) grigio RAL 7035 <i>4 modules splash proof front plate - self-supporting (no frame is required) - RAL 7035 grey</i>	<b>13,75</b>	6	6
		<b>45SP44B</b> Placca 4 moduli stagna con membrana autoportante (non necessita di armatura portafrutti) bianco Banquise (RAL 9016) <i>4 modules splash proof front plate - self-supporting (no frame is required) - Banquise white (RAL 9016)</i>	<b>13,75</b>	6	6

**Nota:** grado di protezione garantito IP55 con apparecchi di comando o altri apparecchi modulari che consentano la chiusura dello sportello nella condizione ordinaria di servizio  
**Note:** IP55 protection degree guaranteed with control devices or other modular devices that allow the closure of the cover in ordinary performing conditions



## Placche stagne (IP44) con sportello rigido IP44 front plates with rigid cover

Cod. Code	Descrizione Description	Info	€	□	□
	<b>45SPQ02</b> Placca 2 moduli con sportello rigido - autoportante (non necessita di armatura portafrutti) - fissaggio con viti su scatola quadrata con interasse 60mm - RAL 7035 <i>IP44 2 modules front plate with rigid cover - self-supporting (no frame is required) To be fixed by screws on square box interax 60mm - RAL 7035</i>		<b>12,68</b>	1	8

**Nota:** grado di protezione garantito IP44 con apparecchi di comando o altri apparecchi modulari che consentano la chiusura dello sportello nella condizione ordinaria di servizio  
**Note:** IP44 protection degree guaranteed with control devices or other modular devices that allow the closure of the lid in ordinary performing conditions

Le dimensioni, salvo diversamente specificato, sono in mm  
Dimensions, except where otherwise specified, are in mm

◇ Prodotto per scatola quadrata  
Product for British Standard square box only

② Prodotto 1 modulo installabile in scatola tonda con altro prodotto 1 modulo  
1 module product installable in round box with another 1 module device

□ Imballo Minimo pcs  
Min. Packaging pcs

□ Imballo Standard pcs  
Std. Packaging pcs





# Contenitori

## Enclosures

Contenitori stagni (IP55) autoportanti da parete RAL 7035 con sportello a membrana cedibile per tubo  
IP55 wall mounted enclosures RAL 7035 with soft membrane cover - self-supporting for duct

336

Dimensioni d'ingombro (in mm) *Dimensions (mm)*

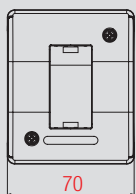

45Q41B

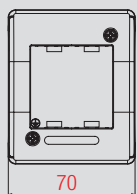
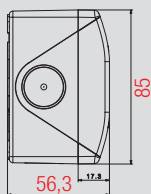

45Q42B

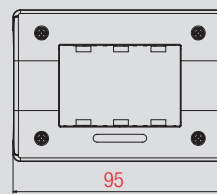
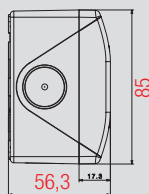

45Q43B

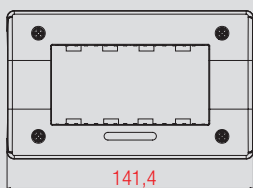
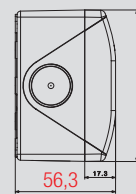

45Q44B

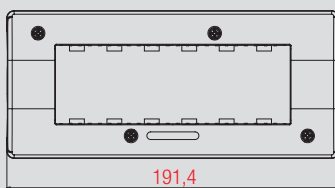
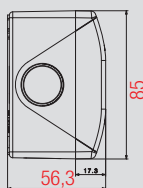

45Q46B

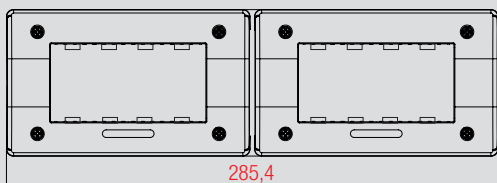
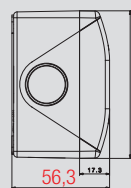

45Q480R

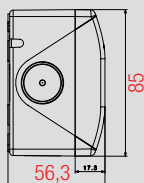

Caratteristiche Tecniche *Technical Features*



Per la disponibilità contattare la rete commerciale  
For availability please contact sales dept.



Disponibilità fino ad esaurimento scorte  
Available until stock out



Prodotto 2 moduli adatto anche per scatola tonda  
2 modules product suitable for round box



Prodotto per scatola rettangolare inglese  
Product for British standard rectangular box



Prodotto per Export  
For Export only

## Contenitori stagni (IP55) autoportanti da parete RAL 7035 con sportello a membrana cedibile per tubo IP55 wall mounted enclosures RAL 7035 with soft membrane cover - self-supporting for duct

	Cod. Code	Descrizione Description	Info	€	□	□
	45ST01	Contenitore da parete 1 modulo 1 module wall mounted enclosure		5,05	1	24
	45ST02	Contenitore da parete 2 moduli 2 modules wall mounted enclosure		5,05	1	24
	45ST03	Contenitore da parete 3 moduli 3 modules wall mounted enclosure		7,48	1	20
	45ST04	Contenitore da parete 4 moduli 4 modules wall mounted enclosure		12,87	20	20
	45ST080R	Contenitore da parete 8 (4+4) moduli - installazione orizzontale 8 (4+4) modules wall mounted enclosure - horizontal installation		22,06	1	6
	45ST99	Scatola di derivazione da parete Wall mounted junction box		5,60	1	20

**Nota:** grado di protezione garantito IP55 con apparecchi di comando o altri apparecchi modulari che consentano la chiusura dello sportello nella condizione ordinaria di servizio

**Note:** IP55 protection degree guaranteed with control devices or other modular devices that allow the closure of the lid in ordinary performing conditions

45ST01

45ST02

45ST03

45ST04

45ST080R





45ST99

337



Sistema 45

## Accessori per contenitori da parete IP40 e IP55 Accessories for IP40 and IP55 wall mounted enclosures

	Cod. Code	Descrizione Description	Info	€	□	□
	45BMT	Adattatore per installazione orizzontale di interruttori automatici magnetotermici su armature standard Sistema 45 o su contenitori/ scatole da parete IP40/IP55 - 2 moduli Adaptor for horizontal installation of MCBs on standard System 45 frames or in wall mounted enclosures/boxes IP40/IP55 - 2 modules		3,58	1	6
	44PC00	Passacavo/passatubo universale - da applicare a sfondabili Ø 24 mm Universal conduit entry - to be fixed on breakable holes Ø 24mm		0,21	10	10
	45PC00	Passacavo/passatubo universale filettato - da applicare a sfondabili Ø 24 mm Universal threaded conduit entry - to be fixed on breakable holes Ø 24mm		0,31	10	10
	45RD03	Raccordo di giunzione scatole per passaggio cavi - da applicare a sfondabili Ø 24mm Box coupler for cables passage - to be fixed on breakable holes Ø 24mm		1,71	10	10

Le dimensioni, salvo diversamente specificato, sono in mm  
Dimensions, except where otherwise specified, are in mm

◇ Prodotto per scatola quadrata  
Product for British Standard square box only

② Prodotto 1 modulo installabile in scatola tonda con altro prodotto 1 modulo  
1 module product installable in round box with another 1 module device

□ Imballo Minimo pcs  
Min. Packaging pcs

□ Imballo Standard pcs  
Std. Packaging pcs



# Contenitori

## Enclosures

Contenitori AVE SEAL IP56 da parete per tubo  
AVE SEAL IP56 wall mounted enclosures for duct

338

Dimensioni d'ingombro (in mm) *Dimensions (mm)*

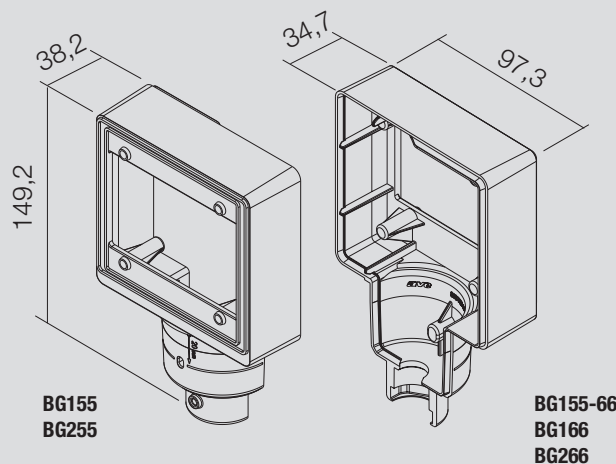
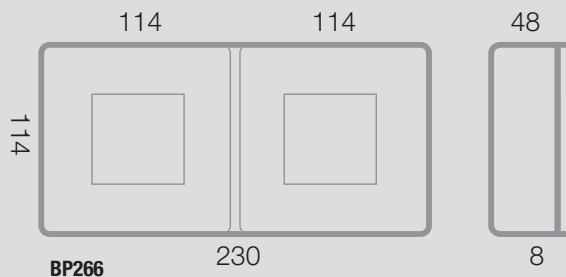
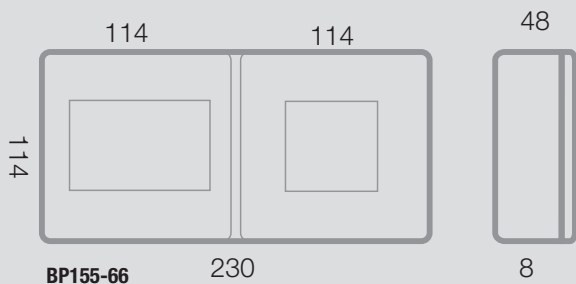
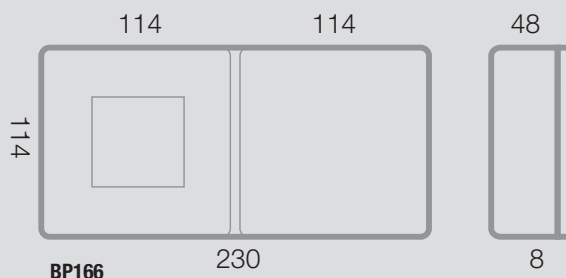
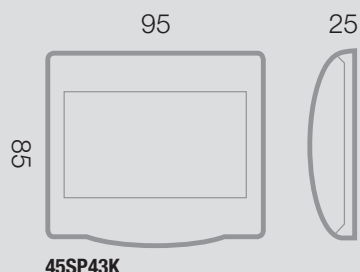
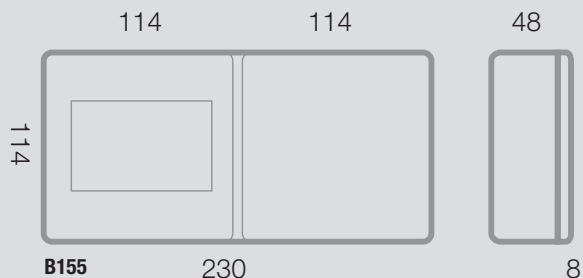

Caratteristiche Tecniche *Technical Features*



Per la disponibilità contattare la rete commerciale  
For availability please contact sales dept.



Disponibilità fino ad esaurimento scorte  
Available until stock out



Prodotto 2 moduli adatto anche per scatola tonda  
2 modules product suitable for round box







Prodotto per scatola rettangolare inglese  
Product for British standard rectangular box



Prodotto per Export  
For Export only

## Contenitori AVE SEAL IP56 da parete per tubo

### AVE SEAL IP56 wall mounted enclosures for duct



	Cod. Code	Descrizione Description	Info	€	□	□
	45ST02K	Contenitore AVE SEAL 2 moduli stagno con sportello apribile a cerniera grado di protezione garantito IP56 <u>anche con spina inserita</u> <i>IP56 splashproof 2 modules enclosure with opening cover guaranteed IP56 protection degree also with plug in</i>		36,33	1	2
45ST02K						
	45ST590/15TS	Contenitore AVE SEAL stagno con sportello apribile a cerniera completo di presa schuko bipasso (universale) 2P+T 10/16A 250V grado di protezione garantito IP56 <u>anche con spina inserita</u> <i>IP56 splashproof with opening cover + 2P+E 10/16A 250V combined schuko + Italian standard socket (universal) - guaranteed IP56 protection also with plug in</i>		40,62	1	2
45ST590/15TS						

339





Sistema 45

## Soluzione AVE SEAL IP55 da incasso Flush-mounted enclosure AVE SEAL IP55 solution

	Cod. Code	Descrizione Description	Info	€	□	□
	45STPK	Piastra adattatrice coperchio AVE SEAL 2 moduli a scatola 3 moduli rettangolare - da completare con n° 1 45SP42K <i>Adapter for IP55 2 modules cover on 3 modules rectangular box to be completed with n. 1 45SP42K</i>		11,68	1	8
45STPK						
	45SP42K	Coperchio AVE SEAL 2 moduli con sportello apribile a cerniera <i>2 modules IP55 cover with opening cover with hinge</i>		32,28	1	10
45SP42K						

## Soluzioni AVE SEAL IP55/IP56 multiple da parete per tubo

### Wall mounted double enclosures AVE SEAL IP55/IP56 solutions for duct

	Cod. Code	Descrizione Description	Info	€	□	□
	45SP42K	Coperchio AVE SEAL 2 moduli con sportello apribile a cerniera <i>2 modules AVE SEAL cover with opening lid with hinge</i>		32,28	1	10
45SP42K						
	45SP43K	Coperchio 3 moduli con sportello con membrana cedibile <i>3 modules cover with soft membrane lid</i>		9,57	1	8
45SP43K						

Le dimensioni, salvo diversamente specificato, sono in mm  
Dimensions, except where otherwise specified, are in mm

◇ Prodotto per scatola quadrata  
Product for British Standard square box only

② Prodotto 1 modulo installabile in scatola tonda con altro prodotto 1 modulo  
1 module product installable in round box with another 1 module device

□ Imballo Minimo pcs  
Min. Packaging pcs

□ Imballo Standard pcs  
Std. Packaging pcs



Soluzioni AVE SEAL IP55/IP56 multiple da parete per tubo  
Wall mounted double enclosures AVE SEAL IP55/IP56 solutions for duct

340



BP155-66



BP166



BP266

Cod. Code	Descrizione Description	Info	€	□	□
BP155-66	Box da parete per 3 moduli IP55 + 2 moduli AVE SEAL - da completare con n° 1 45SP43K + n° 1 45SP42K - grado di protezione garantito IP55 con apparecchi di comando (*) da un lato e prese dall'altro <i>Wall mounted box for IP55 3 modules + AVE SEAL 2 modules to be completed with n°1 45SP43K + n° 1 45SP42K - IP55 protection degree guaranteed with control devices (*) on the one hand and sockets on the other hand</i>	19,96	1	1	
BP166	Box da parete per 2 moduli AVE SEAL IP56 + piastra cieca - da completare con n° 1 45SP42K - grado di protezione garantito IP56 <u>anche con spina inserita</u> <i>Wall mounted box for AVE SEAL IP56 2 modules + blank plate - to be completed with n°1 45SP42K - guaranteed IP56 protection degree also with plug in</i>	19,96	1	1	
BP266	Box da parete per 4 (2+2) moduli AVE SEAL IP56 - da completare con n° 2 45SP42K - grado di protezione garantito IP56 <u>anche con spina inserita</u> <i>Wall mounted box for AVE SEAL IP56 4 (2+2) modules - to be completed with n°2 45SP42K - guaranteed IP56 protection degree also with plug in</i>	19,96	1	1	

- (\*) o altri apparecchi modulari che consentano la chiusura dello sportello nella condizione ordinaria di servizio  
(\*) or other modular devices which allow the closure of the cover

**Esempi installativi** *Installation examples*

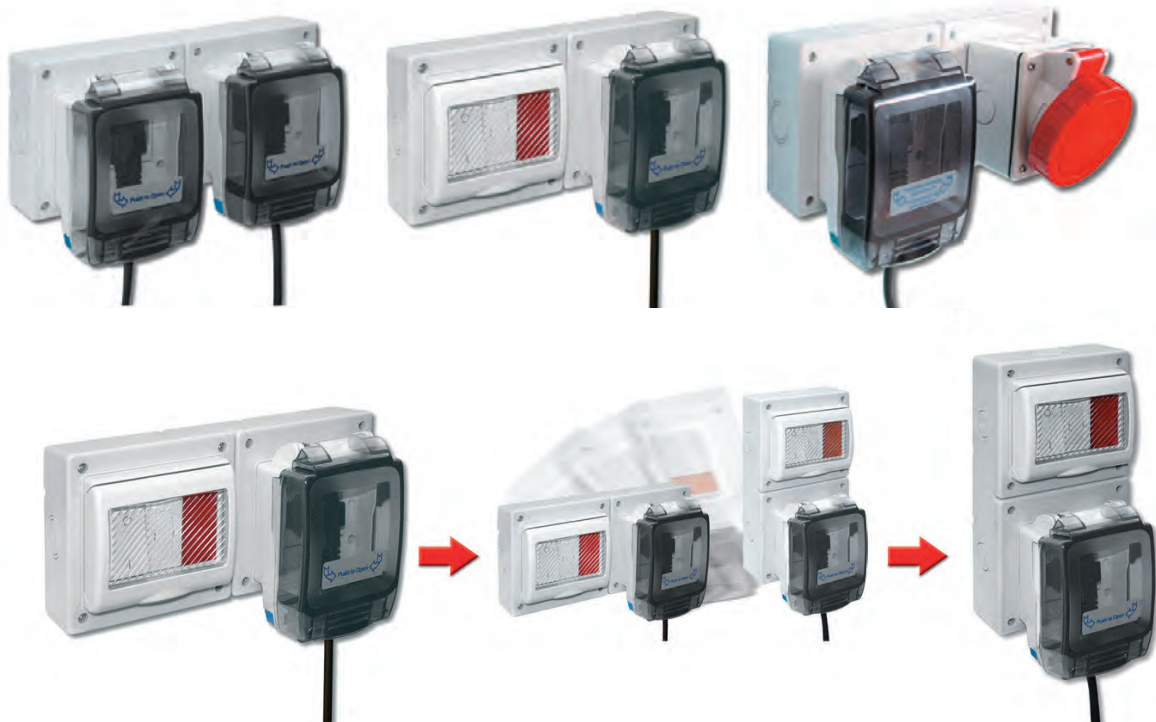

Per la disponibilità contattare la rete commerciale  
For availability please contact sales dept.



Disponibilità fino ad esaurimento scorte  
Available until stock out



Prodotto 2 moduli adatto anche per scatola tonda  
2 modules product suitable for round box



Prodotto per scatola rettangolare inglese  
Product for British standard rectangular box



Prodotto per Export  
For Export only

## Soluzioni AVE SEAL IP55/IP56 abbraccio palo

### Pole fixing AVE SEAL IP55/IP56 solutions

**341**

**45SP42K**
**45ST02K**

**45SP43K**

**BG155**

**BG155-66**

**BG166**

**BG266**

**BG100**

**BG101AP**

Cod. Code	Descrizione Description	Info	€	□	□
45ST02K	Contenitore AVE SEAL 2 moduli stagno con sportello apribile a cerniera - grado di protezione garantito IP56 <u>anche con spina inserita</u> <i>IP56 splashproof 2 modules enclosure with opening lid guaranteed IP56 protection degree also with plug in</i>		<b>36,33</b>	1	2
45SP42K	Coperchio AVE SEAL 2 moduli con sportello apribile a cerniera <i>2 modules AVE SEAL cover with opening lid with hinge</i>		<b>32,28</b>	1	10
45SP43K	Coperchio 3 moduli con sportello con membrana cedibile <i>3 modules cover with soft membrane lid</i>		<b>9,57</b>	1	8
BG155	Box testa-palo a 1 fronte IP55 - installabile su palo BG100 - da completare con n° 1 45SP43K - grado di protezione garantito IP55 con apparecchi di comando (*) <i>Box on pole top with 1 IP55 front - to be installed on pole BG100 to be completed with n. 1 45SP43K - IP55 protection degree guaranteed with control devices (*)</i>		<b>14,13</b>	1	1
BG155-66	Box testa-palo a 2 fronti IP56 + IP55 - installabile su palo BG100 - da completare con n° 1 45SP42K + n° 1 45SP43K - grado di protezione garantito IP55 con apparecchi di comando (*) da un lato e prese dall'altro <i>Box on pole top with 2 IP56 + IP55 fronts - to be installed on pole BG100 to be completed with n. 1 45SP42K - IP55 protection degree guaranteed with control devices (*) on the one hand and sockets on the other hand</i>		<b>20,19</b>	1	1
BG166	Box testa-palo a 1 fronte IP56 - installabile su palo BG100 - da completare con n° 1 45SP42K - grado di protezione garantito IP56 <u>anche con spina inserita</u> <i>Box on pole top with 1 IP56 front - to be installed on pole BG100 to be completed with n. 1 45SP42K - guaranteed IP56 protection degree also with plug in</i>		<b>20,19</b>	1	1
BG266	Box testa-palo a 2 fronti IP56 - installabile su palo BG100 - da completare con n° 2 45SP42K - grado di protezione garantito IP56 <u>anche con spina inserita</u> <i>Box on pole top with 2 IP56 fronts - to be installed on pole BG100 to be completed with n. 2 45SP42K - guaranteed IP56 protection degree also with plug in</i>		<b>20,19</b>	1	1
BG101AP	Accessorio abbraccio palo per contenitore IP56 - installabile su pali con diametro 55/60mm e con diametro 35/40mm a mezzo fascette standard non fornite in dotazione - da completare con n° 1 45ST02K - grado di protezione garantito IP56 <i>Accessory to fix the IP56 enclosure at the pole to be installed on poles with diameter 55/60mm and on poles with diameter 35/40mm by standard bands that are not supplied - to be completed with n. 1 45ST02K - guaranteed IP56 protection degree</i>		<b>10,88</b>	1	10
BG100	Palo isolante per box testa palo - Ø esterno 60mm - lunghezza 1 <i>Insulating pole for garden enclosures - external Ø 60mm - length 1m</i>		<b>36,88</b>	1	1

(\*) o altri apparecchi modulari che consentano la chiusura dello sportello nella condizione ordinaria di servizio

(\*) or others modular devices which allow the closure of the cover

Nota: le dimensioni dei contenitori sono riportate a pag. 388  
 Nota: the dimensions of the enclosures are reported on page 388

## Accessori per contenitori stagni (IP56) da parete

### Accessories for IP56 wall mounted enclosures

**45RD03**

Cod. Code	Descrizione Description	Info	€	□	□
45RD03	Raccordo di giunzione scatole per passaggio cavi - da applicare a sfondabili Ø 24mm <i>Box coupler for cables passage - to be fixed on breakable holes Ø 24mm</i>		<b>1,71</b>	10	10

Le dimensioni, salvo diversamente specificato, sono in mm  
 Dimensions, except where otherwise specified, are in mm

◇ Prodotto per scatola quadrata  
 Product for British Standard square box only

② Prodotto 1 modulo installabile in scatola tonda con altro prodotto 1 modulo  
 1 module product installable in round box with another 1 module device

□ Imballo Minimo pcs  
 Min. Packaging pcs

□ Imballo Standard pcs  
 Std. Packaging pcs